



2025

Ürün Kataloğu

Product Catalogue

VİTAL GRUP

COMPLETE ELEVATOR SYSTEMS

www.vitalasansor.com



9 - 31



35 - 57



59 - 65



68 - 69



71 - 73



PAR

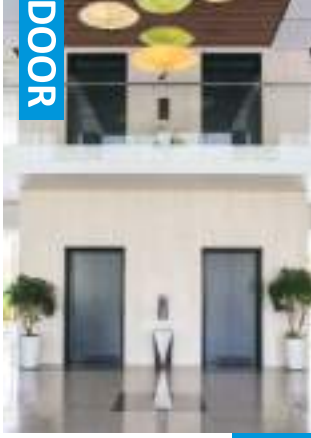

DOOR



PANO



MAK



LIFT

KABİNLER
CABİNS 9

PANORAMİK KABİN
PANORAMIC CABIN 25

HASTANE VE YÜK KABİNİ
HOSPITAL & FREIGHT CABIN 27

TAVAN SEÇENEKLERİ
CEILING OPTIONS 29

TABAN SEÇENEKLERİ
GROUND OPTIONS 30

SÜSPANSİYON TİPLERİ
SUSPENSION TYPE 31

KABİN KAPILARI
CAR DOORS 35

KAT KAPILARI
LANDING DOORS 43

ÇARPMA KAPILARI
SEMI-AUTOMATIC
DOORS 49

MANUEL KAT KAPILARI
SWING LANDING DOORS 57

ARCODE KUMANDA PANOSU
ARCODE CONTROL PANELS 59

ADRİVE KUMANDA PANOSU
ADRİVE CONTROL PANEL 61

ARCUBE KUMANDA PANOSU
ARCUBE CONTROL PANEL 62

HAZIR TESİSAT SİSTEMİ
PREWIRED CONTROL
SYSTEMS 63

BUTONLAR
BUTTONS 65

DIŞLİLİ/DIŞLISIZ MOTORLAR
GEARED/GEARLESS
MACHINES 68

ASANSÖR EKİPMANLARI
ELEVATOR EQUIPMENTS 69

ARABA ASANSÖR
VILLA ASANSÖR
YEMEK ASANSÖR
CAR LIFT
HOME LIFT
DUMB WAITER 71

ENGELLİ PLATFORMU
SPECIAL PEOPLE
PLATAFORM 73

Zirveyi Hisset *Feel The Peak*

HAKKIMIZDA

VITAL GROUP 2012 yılında kurulmuş olup faaliyetlerini Konya'da 13.000 m2 kapalı alanda geliştirmektedir.

VITAL GROUP, kaliteden ödün vermeden ve müşteri gereksinimlerinin rehberliğinde üretim kapasitesini artırmaya devam eden modern, iddialı ve yüksek nitelikli profesyonel ekibinden oluşan bir şirkettir.

Üretimimiz- paket asansör ve asansör yedek parçalarıdır.

AR-GE ekibimiz, müşterinin isteklerini dikkate alarak ve uluslararası güvenlik gerekliliklerinden sapmadan komplike projeler için bireysel çözümler geliştirir ve tasarlar.

VITAL GROUP, müşterilerine rakipsiz bir ürün sunabilmek için yenilik ve kalite arayışı içinde üretimini sürekli geliştirmekte ve modernize etmektedir.

VİZYONUMUZ

Kalitenin bir yaşam biçimi olarak sektörümüz içerisinde ilerlemenin ve gelişmenin alt yapısı olmasını sağlamak ve dünyada bu anlayışın öncülerinden olmaktır.

Bu amaç doğrultusunda; ürettiğimiz ürün ve hizmet kalitesini sürekli artırmak, teknolojiyi yakından takip etmek, sürekli değişim ve yeniliği ilke edinmek, sektörümüzün lokomotif yüklenicisi olmak, müşterilerimizle uzun vadeli birliktelik oluşturmak ve bu birlikteliği sürekli güncel tutarak aranan marka haline gelmektir.

MİSYONUMUZ

Toplam kalite yönetimini esas alarak ve sektördeki son teknolojileri kullanarak, sıfır hatalı, mükemmellik seviyesine yakın, maksimum kalitede ve en uygun fiyat aralığında ürün ve hizmet sağlama faaliyetlerini müşterilerimize sunmaktır.

KALİTE POLİTİKAMIZ

- ISO 9001 Kalite Yönetim Sistemi amaç ve bağlamına uygun olarak, Vizyon ve Misyonumuz ışığında Kalite hedeflerimize ulaşmayı,
- Kurum içi ve kurum dışı eğitimlerle, kalite alanında tüm personelimizin farkındalığını arttırarak müşteri portföyümüzü genişletmeyi,
- Sunduğumuz satış sonrası hizmetlerle müşterilerimizin memnuniyetini arttırmayı ve marka değerimizi en yükseğe taşımayı,
- Gelişen teknolojiyi takip ederek ürün ve personelimizde sürekli iyileştirme faaliyetlerinde bulunmayı, çalışanlarımızın katılımını sağlamayı,
- Endüstri 4.0 ve diğer öncü ve fark yaratan teknolojik uygulamaları hayata geçirerek, sürdürülebilir değerler oluşturmayı,
- Müşterilerimizin değişen talep, öneri ve şikayetlerini analiz ederek, değişim ihtiyaçlarına göre, sürekli iyileştirici faaliyetlerle çözümler sunmayı taahhüt etmekteyiz.

Компания VITAL GROUP была основана в 2012 году и осуществляет свою деятельность на производственной площадке площадью 13 000 м² в городе Конья.

VITAL GROUP — это компания, которая неуклонно увеличивает производственные мощности, ориентируясь на потребности клиентов и уделяя приоритетное внимание качеству. Наша команда состоит из современных, амбициозных и высококвалифицированных профессионалов.

Наша продукция включает:

Комплектные лифты и запасные части для лифтов.

Команда AR-GE (исследования и разработки) разрабатывает индивидуальные решения для сложных проектов, учитывая запросы клиентов и международные стандарты безопасности.

VITAL GROUP постоянно совершенствует производство, предлагая клиентам непревзойденное качество, инновации и модернизацию. Кроме того, наша компания успешно реализует проекты, которые многие другие компаний в лифтовой отрасли считают невозможными или слишком сложными.

Наша Видение

Мы стремимся быть лидерами отрасли, делая качество образом жизни, содействуя прогрессу и создавая основы для дальнейшего развития.

Для достижения этой цели мы:

Постоянно улучшаем качество производимых продуктов и предоставляемых услуг. Следим за технологическими новшествами.

Внедряем постоянные изменения и инновации. Действуем как локомотив индустрии.

Стремимся стать ведущим брендом, поддерживая долгосрочные отношения с клиентами и оставаясь актуальными на рынке.

Наша Миссия

Используя новейшие технологии в отрасли и уделяя особое внимание общему управлению качеством, мы стремимся обеспечить наших клиентов продуктами и услугами высокого качества по оптимальной цене.

Как VITAL GROUP,

Проводим анализ потребностей рынка.

Сосредоточены на производстве безопасных и надежных продуктов.

Постоянно развиваем инновационные технологии и процессы.

Мы стремимся оправдать ожидания наших клиентов и предоставить продукцию и услуги, соответствующие мировым стандартам.

About us

VITAL GROUP was established in 2012 and developing its activities in a closed area of 13,000 square metres in Konya.

VITAL GROUP is a company consisting of a modern, determined and highly qualified professional team that continues to increase its production capacity without compromising quality and under the supervision of customer requirements.

Our production is full set elevators and elevators spare parts.

Our R&D team develops and designs individual solutions for complex projects, taking into account the customer's wishes and without deviating from international safety requirements.

VITAL Group is constantly developing and modernising its production in search of innovation and quality to offer its customers an unrivalled product.

OUR VISION

To ensure that quality is the infrastructure of progress and development in our industry as a way of life and to be one of the pioneers of this approach in the world.

With this aim, we continuously increase the quality of the products and services we produce, to constantly follow the technological developments, to adopt the philosophy of continuous change and innovation, to be the locomotive contractor of our sector, to create a long-term partnership with our customers and to become a recognised brand by keeping this partnership constantly updated.

OUR MISSION

is to provide flawless products and services to our customers based on total quality management and using the latest technologies in the sector, with zero errors, close to perfection, maximum quality and the most appropriate price range.

Our Quality Policy

Achieve our quality objectives in light of our vision and mission, in accordance with ISO 9001 Quality Management System (QMS)

To expand our customer portfolio by increasing the quality awareness of all our employees through internal and external training.

To increase our customer satisfaction and maximise our brand value through our after-sales services,

To implement continuous improvement in our products by following technological development and ensuring the involvement of our employees.

- To create sustainable values by implementing Industry 4.0 and other pioneering and distinctive technological applications,

We are committed to analysing the changing requests, suggestions and complaints of our customers and providing solutions with continuous improvement activities according to their changing needs.

معلومات عنا

تأسست VITAL GROUP في عام ٢٠١٢ وتقوم بتطوير أنشطتها في منطقة تبلغ مساحتها ١٣٠٠٠ متر مربع في مدينته قونية.

VITAL GROUP هي شركة تتكون من فريق مخترف ومؤهل تأهيلا عاليا يواصل زيادة طاقته الإنتاجية دون المساس بالجودة وتحت إشراف متطلبات العملاء. يشمل إنتاجنا المصاعد وأجزائها المختلفة.

يعمل فريق البحث والتطوير لدينا على تصميم وتطوير حلول مخصصة للمشاريع المعقدة، مع الالتزام برغبات العملاء ومعايير السلامة الدولية. تسعى مجموعة فيتال باستمرار إلى الابتكار، والجودة، لتقديم منتجات متميزة لا مثيل لها لعملائنا.

رؤيتنا

رؤيتنا هي جعل الجودة أسلوب حياة وأساسا للتقدم والتميز في قطاع المصاعد، لنصبح أحد الرواد العالميين في هذا المجال. نسعى لتحقيق ذلك من خلال:
- تعزيز جودة منتجاتنا وخدماتنا بشكل مستمر.
- متابعة أحدث التقنيات عن كثب.
- اعتماد التغيير والابتكار كنهج دائم.
- بناء علاقات تعاون طويلة الأمد مع عملائنا.
- أن نصبح علامة تجارية مرغوبة عالميا.

مهمتنا

مهمتنا هي تقديم منتجات وخدمات خالية من العيوب، أقرب إلى الكمال، بأعلى جودة وأفضل أسعار. نعتمد على إدارة الجودة الشاملة وأحدث التقنيات لضمان رضا عملائنا.

سياسة الجودة.

تحقيق أهداف الجودة بما يتماشى مع رؤيتنا ورسالتنا، وفقاً لنظام إدارة الجودة ISO 9001.

رفع وعي الموظفين حول الجودة من خلال التدريبات الداخلية والخارجية.

تعزيز رضا العملاء وزيادة قيمة علامتنا التجارية عبر خدمات ما بعد البيع المتميزة.

تحسين المنتجات والموارد البشرية باستخدام أحدث التقنيات وضمان مشاركة الموظفين.

تطبيق أحدث الابتكارات مثل تقنيات الصناعة 4.0، لخلق قيم مستدامة.

تحليل احتياجات العملاء المتغيرة وتقديم حلول فعالة تلبى تطلعاتهم.



VITAL GRUP
COMPLETE ELEVATOR SYSTEMS

VIPAR

VIDOOR

VIPANO

VIMAK

VILIFT



MR (Machine-Room) Elevators 
Makine Daireli Asansörler

MRL (Machine-Room-Less) Elevators 
Makine Dairesiz Asansörler

Hydraulic Elevators 
Hidrolik Asansörler



VC-01



ÖZELLİKLER

ARKA DUVAR	: YARIM / TAM BOY AYNA
TAVAN	: LAZER KESİM PASLANMAZ
TABAN	: GRANİT / PVS
AKSESUAR	: AYNA PASLANMAZ
YAN DUVAR	: SATİNE PASLANMAZ

ОПИСАНИЕ

Задняя Стена	: Зеркало Горизонтальное / Вертикальное
Потолок	: Зеркальная Нержавейка
Пол	: ПВХ
Аксессуары	: Зеркальная Нержавейка
Боковые Стены	: Шлифованная Нержавейка

الحائط الخلفي : مرآة كامله / نصف مرآة
السقف : قص ليزر
الأرضيه : من البي في سي المقوى
الإكسسوارات : مرآة غير قابله للصدأ
الحائط الجانبي : فولاذ مقاوم للصدأ

الخصائص

FEATURES

BACK WALL	: HALF / FULL MIRROR
CEILING	: LASER CEILING
FLOOR	: PVC / GARNİT GALAXY
ACCESSORIES	: MIRROR STAINLESS
SIDE WALL	: STAINLESS STEEL

SATİNE ÇEŞİTLERİ STAINLESS MODELS



NO: 4 SATIN

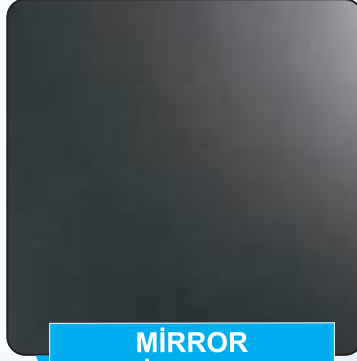

MİRROR
Tİ-BLACK



HAİRLİNE
Tİ-GOLD



MİRROR
Tİ-COPPER



HAİRLİNE
Tİ-BLACK

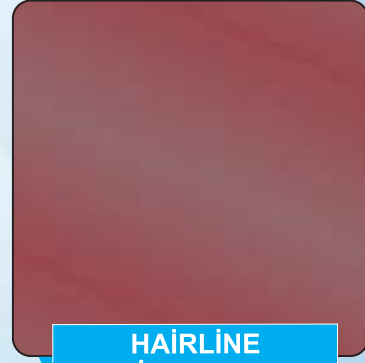

HAİRLİNE
Tİ-BRONZE



MİRROR

VC-02



ÖZELLİKLER

ARKA DUVAR	: YARIM / TAM BOY AYNA
TAVAN	: LAZER KESİM PASLANMAZ
TABAN	: GRANİT / PVS
AKSESUAR	: AYNA PASLANMAZ
YAN DUVAR	: SATİNE PASLANMAZ

ОПИСАНИЕ

Задняя Стена	: Зеркало Горизонтальное / Вертикальное
Потолок	: Зеркальная Нержавеика
Пол	: ПВХ
Аксессуары	: Зеркальная Нержавеика
Боковые Стены	: Шлифованная Нержавеика

الحائط الخلفي : مرآة كامله / نصف مرآة
السقف : قص ليزر
الأرضيه : من البي في سي المقوى
الإكسسوارات : مرآة غير قابله للصدأ
الحائط الجانبي : فولاذ مقاوم للصدأ

الخصائص

FEATURES

BACK WALL	: HALF / FULL MIRROR
CEILING	: LASER CELILING
FLOOR	: PVC / GARNİT GALAXY
ACCESSORIES	: MIRROR STAINLESS
SIDE WALL	: STAINLESS STEEL

SATİNE ÇEŞİTLERİ STAINLESS MODELS



NO: 4 SATIN

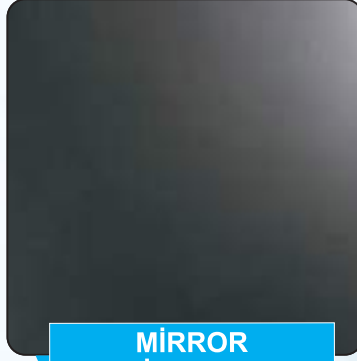

MİRROR
Tİ-BLACK



HAİRLİNE
Tİ-GOLD



MİRROR
Tİ-COPPER



HAİRLİNE
Tİ-BLACK



HAİRLİNE
Tİ-BRONZE



MİRROR

VC - 03



ÖZELLİKLER

ARKA DUVAR : YARIM / TAM BOY AYNA
TAVAN : LAZER KESİM PASLANMAZ
TABAN : GRANİT / PVS
AKSESUAR : SARI AYNA PASLANMAZ
YAN DUVAR : DEKORATİF PASLANMAZ

ОПИСАНИЕ

Задняя Стена : Зеркало Горизонтальное / Вертикальное
Потолок : Зеркальная Нержавейка
Пол : ПВХ
Аксессуары : Зеркальная Нержавейка
Боковые Стены : Шлифованная Нержавейка

الحائط الخلفي : مرآة كاملة / نصف مرآة
السقف : قص ليزر
الأرضيه : من البني في سي المقوى
الإكسسوارات : مرآة غير قابله للصدأ
الحائط الجانبي : فولاذ مقاوم للصدأ

الخصائص

FEATURES

BACK WALL : HALF / FULL MIRROR
CEILING : LASER CEILING
FLOOR : PVC / GARNİT GALAXY
ACCESSORIES : MIRROR STAINLESS
SIDE WALL : STAINLESS STEEL

SARI DEKORATİF ÇEŞİTLERİ GOLD DECORATIVE MODELS



SG-238 MIRROR
ETCHED TI-GOLD



SG-281 MIRROR
ETCHED TGOLD



SG-223 MIRROR
ETCHED TI-GOLD



SG-287 MIRROR
ETCHED TGOLD



SG-218 MIRROR
ETCHED TI-GOLD



SG-203 MIRROR
ETCHED TI-GOLD



SG-285 MIRROR
ETCHED TGOLD



SG-289 MIRROR
ETCHED TGOLD



SG-280 MIRROR
ETCHED TI-GOLD



SG-206 MIRROR
ETCHED TI-GOLD



SG-219 MIRROR
ETCHED TI-GOLD



SG-290 MIRROR
ETCHED TGOLD



SG-215 MIRROR
ETCHED TI-GOLD

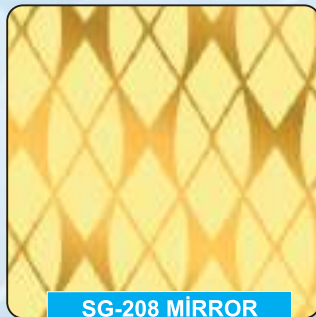

SG-208 MIRROR
ETCHED TI-GOLD

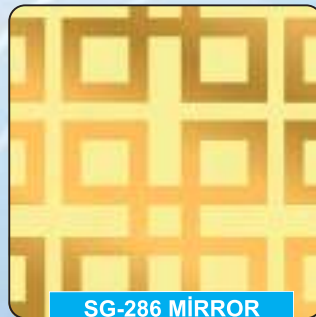

SG-286 MIRROR
ETCHED TGOLD

VC-04



ÖZELLİKLER

ARKA DUVAR	: YARIM / TAM BOY AYNA
TAVAN	: LAZER KESİM PASLANMAZ
TABAN	: GRANİT / PVS
AKSESUAR	: AYNA PASLANMAZ
YAN DUVAR	: DEKORATİF PASLANMAZ

ОПИСАНИЕ

Задняя Стена	: Зеркало Горизонтальное / Вертикальное
Потолок	: Зеркальная Нержавейка
Пол	: Гранит
Аксессуары	: Зеркальная Нержавейка
Боковые Стены	: Декоративная Нержавейка

الحائط الخلفي : مرآة كاملة / نصف مرآة
السقف : ليزر
الأرضيه : من البى فى سى المقوى
الإكسسوارات : مرآة غير قابله للصدأ
الحائط الجانبى : فولاذ مقاوم للصدأ مزخرف

الخصائص

FEATURES

BACK WALL	: HALF / FULL MIRROR
CEILING	: LASER CEILING
FLOOR	: PVC / GARNIT
ACCESSORIES	: MIRROR STAINLESS
SIDE WALL	: DECORATIVE STAINLESS STEEL

SATİNE DEKORATİF ÇEŞİTLERİ

STAINLESS DECORATIVE MODELS

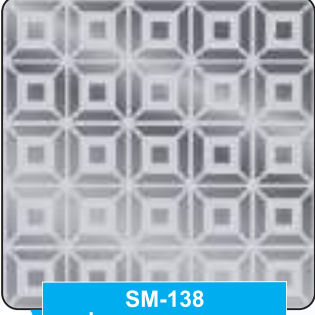

SM-138
MIRROR ETCHED



SM-181
MIRROR ETCHED



SM-123
MIRROR ETCHED



SM-187
MIRROR ETCHED



SM-118
MIRROR ETCHED

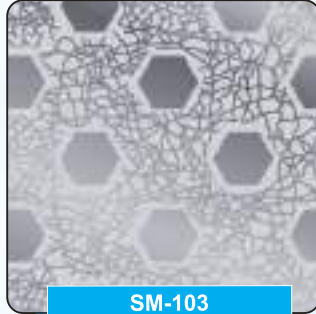

SM-103
MIRROR ETCHED

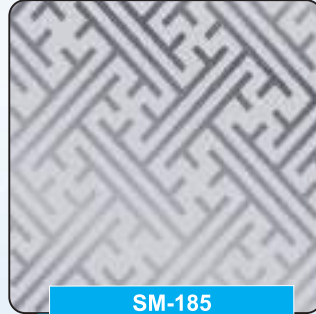

SM-185
MIRROR ETCHED



SM-189
MIRROR ETCHED



SM-180
MIRROR ETCHED

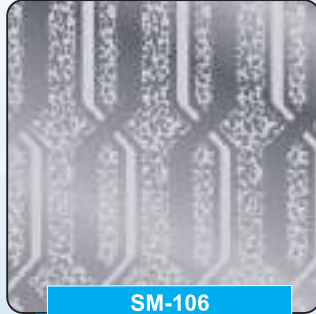

SM-106
MIRROR ETCHED



SM-119
MIRROR ETCHED



SM-190
MIRROR ETCHED



SM-115
MIRROR ETCHED



SM-108
MIRROR ETCHED

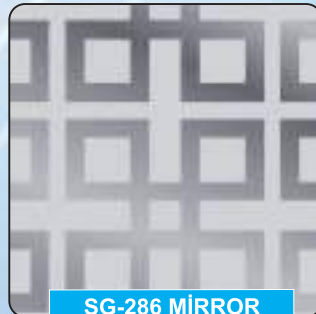

SG-286 MIRROR
ETCHED T GOLD

VC - 05



ÖZELLİKLER

ARKA DUVAR : YARIM / TAM BOY AYNA
TAVAN : LAZER KESİM PASLANMAZ
TABAN : GRANİT / PVS
AKSESUAR : AYNA PASLANMAZ
YAN DUVAR : LAMİNANT

ОПИСАНИЕ

Задняя Стена : Зеркало Горизонтальное / Вертикальное
Потолок : Зеркальная Нержавейка
Пол : ПВХ
Аксессуары : Зеркальная
Боковые Стены : Ламинат

الخصائص

الحائط الخلفي : مرآة كاملة
السقف : قص ليزر
الأرضيه : رخام طبيعي
الإكسسوارات : سوداء غير قابله للصدأ
الحائط الجانبي : حائط خشبي

FEATURES

BACK WALL : HALF / FULL MIRROR
CEILING : LASER CELILING
FLOOR : PVC / GARNİT GALAXY
ACCESSORIES : MIRROR STAINLESS
SIDE WALL : STAINLESS STEEL

LAMİNANT KAPLAMA ÇEŞİTLERİ

LAMİNATE COATING MODELS



KUDÜM



PEKİN



PATİK



SONOMO



MAHAGON LİDO



TESBİH



HARELİ CEVİZ



AKMEŞE



NOCE
MARİA LUİSA



ANTİK DARK



ANTİK LİGHT



DOĞAL HUŞ



LİZBON



FLORANSA

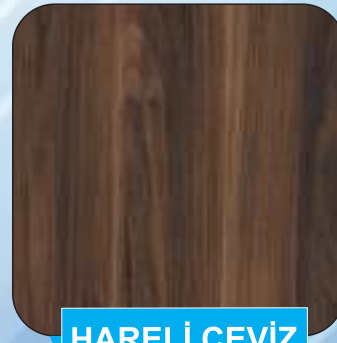

HARELİ CEVİZ



KRİSTAL

90 - 06



ÖZELLİKLER

ARKA DUVAR : YARIM/ TAM BOY AYNA
TAVAN : LAZER KESİM PASLANMAZ
TABAN : GRANİT / PVS
AKSESUAR : AYNA PASLANMAZ
YAN DUVAR : YATAY DÖŞEME LAMİNANT

ОПИСАНИЕ

Задняя Стена : Зеркало Горизонтальное / Вертикальное
Потолок : Зеркальная Нержавейка
Пол : Пвх
Аксессуары : Зеркальная Нержавейка
Боковые Стены : Ламинат

الحائط الخلفي : مرآة كاملة / نصف مرآة
السقف : ليزر
الأرضية : من البني في سي المقوى
الإكسسوارات : مرآة غير قابله للصدأ
الحائط الجانبي : حائط خشبي أفقي

الخصائص

FEATURES

BACK WALL : FULL BLACK MIRROR
CEILING : LASER CEILING
FLOOR : PVC / GRANİT GALAXY
ACCESSORIES : MIRROR STAINLESS
SIDE WALL : HORIZONTAL LAMINATE

VİC - 07

ÖZELLİKLER

- ARKA DUVAR : YARIM BOY AYNA / DEKORATIF TAŞ
TAVAN : LAZER KESİM PASLANMAZ
TABAN : GRANİT / PVS
AKSESUAR : AYNA PASLANMAZ
YAN DUVAR : LAMINANT , ALTIN PASLANMAZ

ОПИСАНИЕ

- Задняя Стена : Зеркало Горизонтальное, Декоративный Камень
Потолок : Зеркальная Нержавейка
Пол : Гранит
Аксессуары : Зеркальная Нержавейка
Боковые Стены : Ламинат, Зеркальная Нержавейка

الخصائص

- الحائط الخلفي : نصف مرآة / حجر طبيعي
السقف : ليزر
الأرضية : رخام طبيعي
الإكسسوارات : مرآة ذهبي غير قابل للصدأ
الحائط الجانبي : حائط خشبي. ستاليس ستيل ذهبي

FEATURES

- BACK WALL : HALF MIRROR, DECORATIVE STONE
CEILING : LASER CEILING
FLOOR : PVC / GARNİT GALAXY
ACCESSORIES : GOLDEN MIRROR STAINLESS
SIDE WALL : LAMINATE, GOLD MIRROR STAINLESS

80 - 08
VC - 08



ÖZELLİKLER

ARKA DUVAR : YARIM / TAM BOY AYNA
TAVAN : LAZER KESİM PASLANMAZ
TABAN : GRANİT / PVS
AKSESUAR : AYNA PASLANMAZ
YAN DUVAR : YATAY DÖŞEME LAMİNANT

ОПИСАНИЕ

Задняя Стена : Зеркало Горизонтальное / Вертикальное
Потолок : Зеркальная Нержавейка
Пол : Пвх
Аксессуары : Зеркальная Нержавейка
Боковые Стены : Ламинат

الحناط الخلفي : مرآة كامله / نصف مرآة
السقف : قص ليزر
الأرضيه : رخام طبيعي
الإكسسوارات : مرآة ذهبي غير قابله للصدأ
الحناط الجانبي : حناط خشبي

الخصائص

FEATURES

BACK WALL : HALF / FULL MIRROR
CEILING : LASER CELILING
FLOOR : PVC / GARNİT
ACCESSORIES : GOLD MIRROR STAINLESS
SIDE WALL : HORIZONTAL LAMINATE

VİC - 09

ÖZELLİKLER

ARKA DUVAR	: SİYAH AYNA
TAVAN	: LAZER KESİM PASLANMAZ
TABAN	: GRANİT / PVS
AKSESUAR	: SİYAH AYNA PASLANMAZ
YAN DUVAR	: LAMİNANT

ОПИСАНИЕ

Задняя Стена	: Зеркало Горизонтальное / Вертикальное
Потолок	: Зеркальная Нержавейка
Пол	: Пвх
Аксессуары	: Зеркальная Нержавейка
Боковые Стены	: Ламинат

الخصائص
الحائط الخلفي : مرآة سوداء كامله
السقف : قص ليزر
الأرضيه : رخام طبيعي
الإكسسوارات : مرآة سوداء غير قابله للصدأ
الحائط الجانبي : حائط خشبي

FEATURES

BACK WALL	: FULL BLACK MIRROR
CEILING	: LASER CELILING
FLOOR	: PVC / GARNİT
ACCESSORIES	: BLACK MIRROR STAINLESS
SIDE WALL	: LAMINATE

VC-10



ÖZELLİKLER

ARKA DUVAR : YARIM / TAM BOY AYNA
TAVAN : LAZER KESİM PASLANMAZ
TABAN : GRANİT / PVS
AKSESUAR : SİYAH AYNA PASLANMAZ
YAN DUVAR : LAMİNE CAM

ОПИСАНИЕ

Задняя Стена : Зеркало Горизонтальное / Вертикальное
Потолок : Зеркальная Нержавейка
Пол : Ламинированное Стекло
Аксессуары : Зеркальная Нержавейка
Боковые Стены : Ламинированное Стекло

الحائط الخلفي : مرآة سوداء كامله
السقف : ليزر

الأرضيه : زجاج مقوى ضد الكسر
الإكسسوارات : مرآة سوداء غير قابله للصدأ
الحائط الجانبي : حائط زجاجي

الخصائص

FEATURES

BACK WALL : HALF / FULL MIRROR
CEILING : LASER CEILING
FLOOR : PVC / GRANİT GALAXY
ACCESSORIES : MIRROR STAINLESS
SIDE WALL : DECORATIVE GLASS

MDF & CAM MODELLERİ

MDF & GLASS MODELS



VG-106



VG-109



VG-111

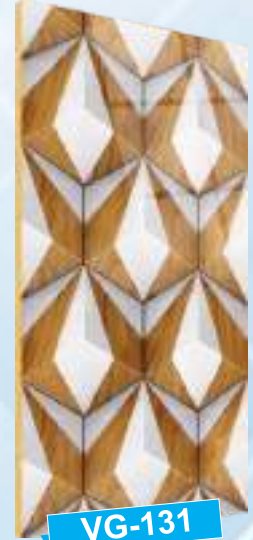

VG-131



VG-132



VG-133



VG-134



VG-135



VG-136



VG-137



VG-138



VG-139



VC-17

DETAYLAR

Panoramic asansör serisi ürünleri estetiği, ileri teknolojiyi ve sanat konseptini birleştirir. Tasarımı ve performansı ile alışveriş merkezleri, otel ve turizm merkezlerinin yaygın kullanımı için tercih edilen dikey ulaşım çözümü olmaktadır.

DETAILS

Panoramic lift series products combine aesthetics, advanced technology and art concept. With its design and performance, it is the preferred vertical transportation solution for the widespread use of shopping centers, hotels and tourism centers.

VC-18

ÖZELLİKLER

- 1,5 mm sac kabin duvarları
- 304 kalite paslanmaz çelik
- Hem iç hem dış paslanmaz kaplama
- Tamamı lazer kesimli parçalar
- Üç cepeye kadar cam seçeneği
- Farklı taban ve tavan seçenekleri
- Oval cam seçeneği
- Lamine cam koruma sertifikalı

FEATURES

- 1,5 mm sheet metal cabin wall
- AISI304 quality stainless steel
- Both internal and external stainless coating
- All parts are laser cut
- Easy assembly structure
- Technical bends for extra strength
- Different floor and ceiling options
- Special applications made on request



VC-19

DETAYLAR

Hastanelerin gündelik çalışmaları göz önüne alındığında. Hastane ulaşım verimliliğini önemli ölçüde iyileştirmek için verimli, güvenli ve güvenilir hastane ve yük asansörlerini özel olarak tasarlanmaktadır.

DETAILS

Considering the daily work of hospitals. Is specially designing efficient, safe and reliable hospitals and freight elevators to significantly improve hospital transportation efficiency.

VC-20

ÖZELLİKLER

1,5 mm galvanizli sac
E.S. Boyalı yan duvarlar
Satine paslanmaz yan duvarlar
Lazer tavan
Kolay takılabilir küpeşte
Aydınlatma ve havalandırma bağlantıları
Alüminyum çeta taban
Farklı taban seçenekleri
Tercihe bağlı sandık ambalaj
Titreşimi önleyen özel bükümler ve takozlar

PROPERTIES

1.5 mm galvanized iron sheet
E.S. Painted side walls
Satine stainless side walls
Laser ceiling
Easily installed rail
Lighting and ventilation connections
Aluminium knurled ceta base
Different base options
Optional packing crate
Special bends and dampers that prevent vibration





VR-37



VR-31



VR-30



VR-32



VR-36



VR-45



VR-01



VR-26



VR-29



VR-28



VR-47



VR-09



VR-48



VR-33



VR-41



VR-46



VR-34



VR-27



VR-23

PVC | PVC



* PVT-ESS, PVT-3714 ve PVT-1341 modelleri 450x450 mm karo şeklindedir. Diğer modeller 1500x1500 mm tek parça halindedir.
* PVT-ESS, PVT-3714 and PVT-1341 models are 450x450 mm tile. Other models are 1500x1500 mm in one piece.

Cam | Glass



Granit



ASANSÖR SÜSPANSİYON SİSTEMLERİ *LIFT SUSPENSION SYSTEMS*



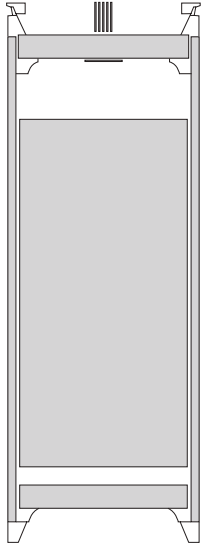

1:1 MR

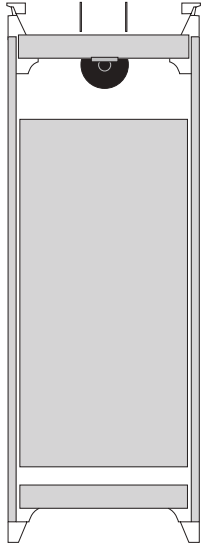

2:1 MR

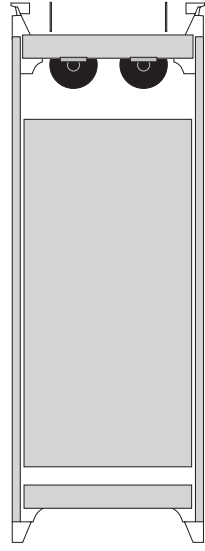

2:1 MR

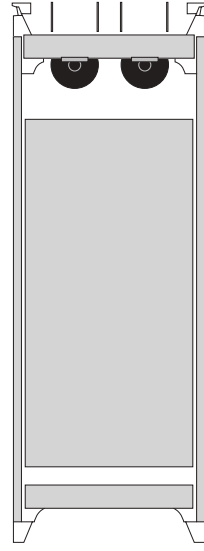

4:1 MR

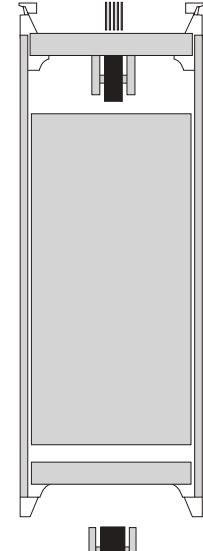

2:1 MR

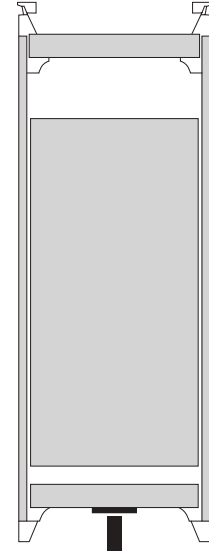

1:1 HDR

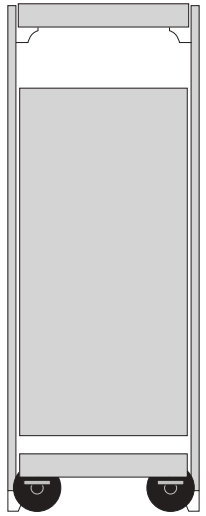

2:1 MRL

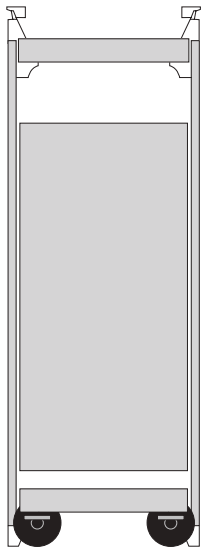

4:1 MRL

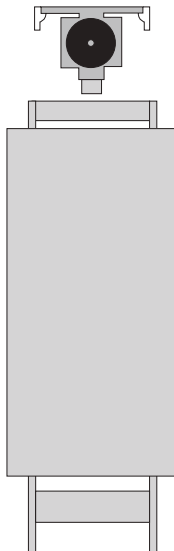

2:1 L HDR

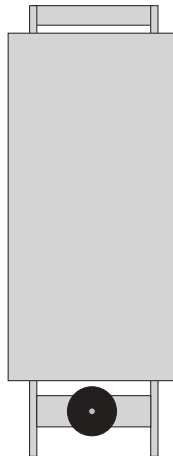

1:1 L MRL

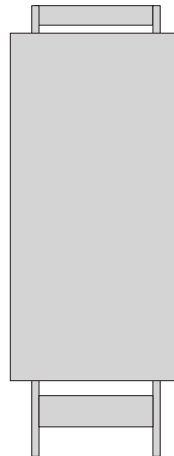

1:1 L MRL

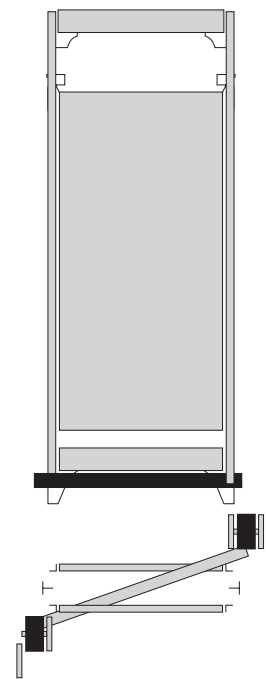

1:1 T HDR



MR 1:1 standart süspansiyon
MR 1:1 standart car frame



MR 1:1 özel süspansiyon
MR 1:1 special car frame



MRL 2:1 üstten T palanga
MRL 2:1 top T traction



MRL 2:1 üstten palanga
MRL 2:1 top traction



MRL 2:1 alttan palanga
MRL 2:1 bottom traction



C ve L karkas tipleri
C and L types frames



MR 1:1 Ağırlık Şasesi
MR 1:1 Cwt. Frame



MRL 2:1 Ağırlık şasesleri
MRL 2:1 Cwt. Frames



Çift sıra ağırlık şasesleri
Double Row Cwt. frames



MR 1:1 Makine Sehpası
MR 1:1 Machine Frame

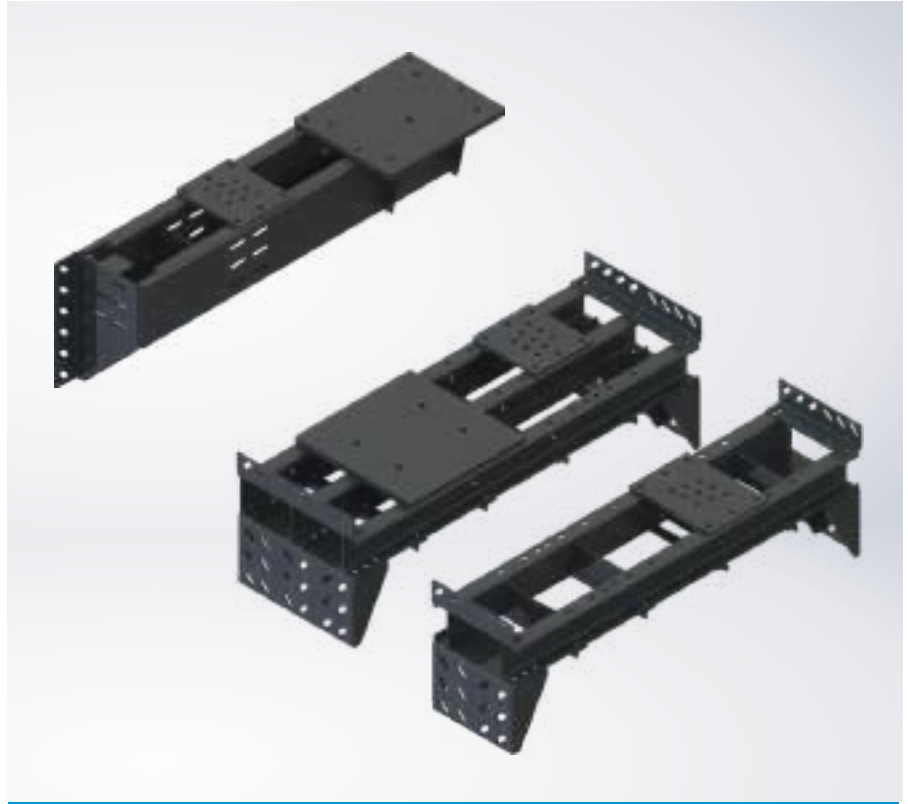

MRL 2:1 makine sehpalari, raya montaj / duvara montaj
MRL 2:1 machine frames, rail mounting / wall mounting

Premium Series
VT02P

Kabin Kapısı | Cabin Doors

V
I
DOOR



2 PANEL
TELESKOPİK KABİN KAPISI

Teleskopik 2 Panel Kabin Kapısı
Teleskopik 2 Panel Cabin Door

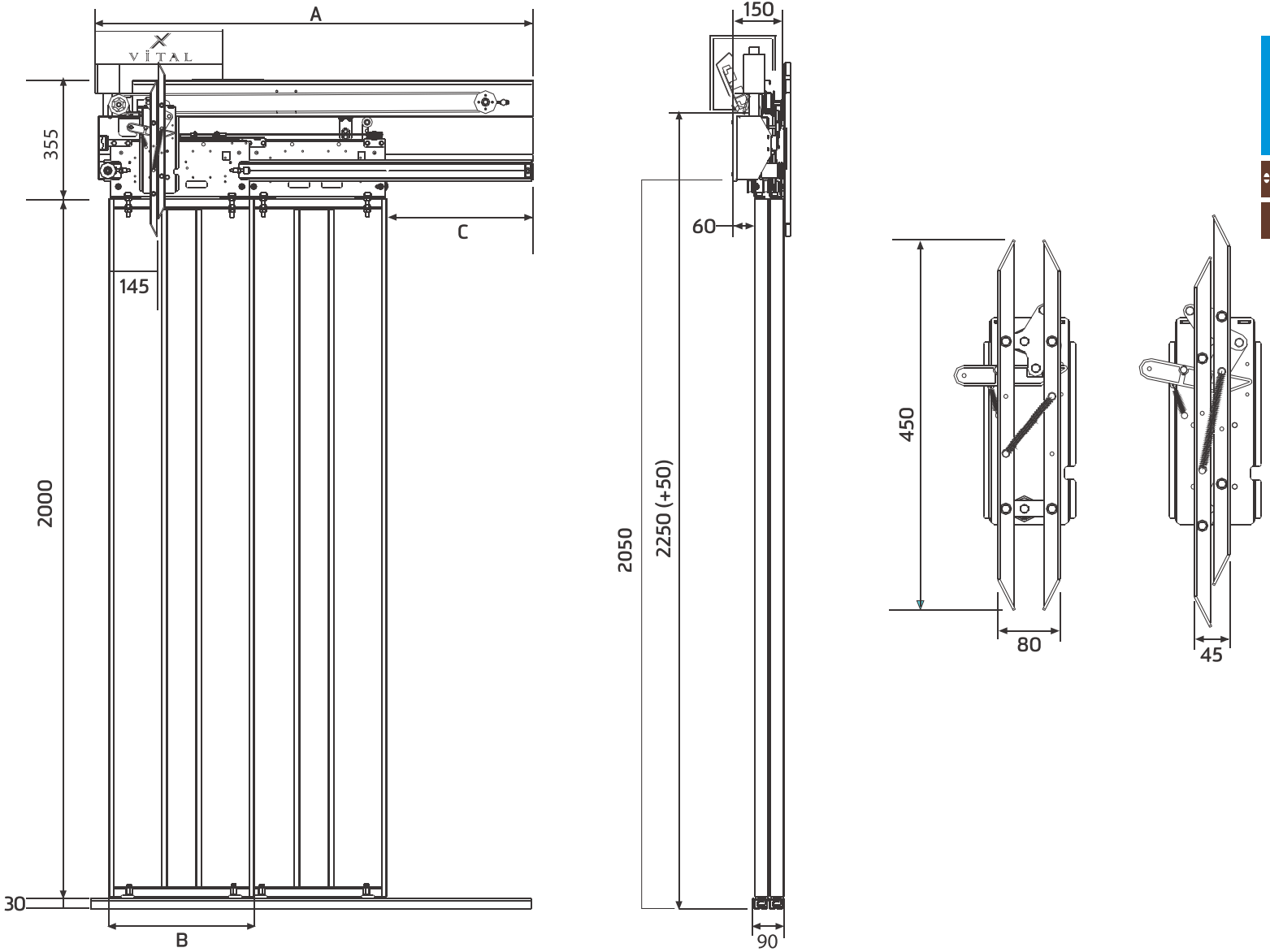

VİTAL DOOR

Ölçüler / Dimensions

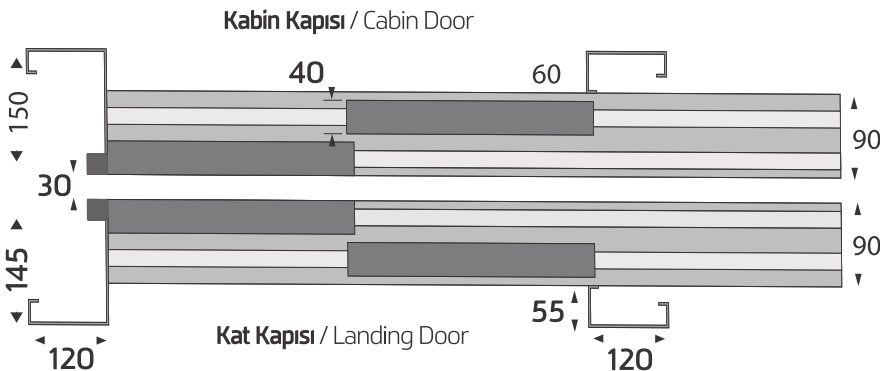

PL (mm)	A (mm)	B (mm)	C (mm)
700	1100	370	380
800	1250	420	430
900	1400	470	480
1000	1550	520	530
1100	1700	570	580
1200	1850	620	630
1300	2000	670	680
1400	2150	720	730
1500	2300	770	780
1600	2450	820	830

Premium Series
VT03P

Kabin Kapısı | Cabin Doors

V
I
DOOR



3 PANEL
TELESKOPIK KABİN KAPISI

Teleskopik 3 Panel Kabin Kapısı
Telescopic 3 Panel Cabin Door

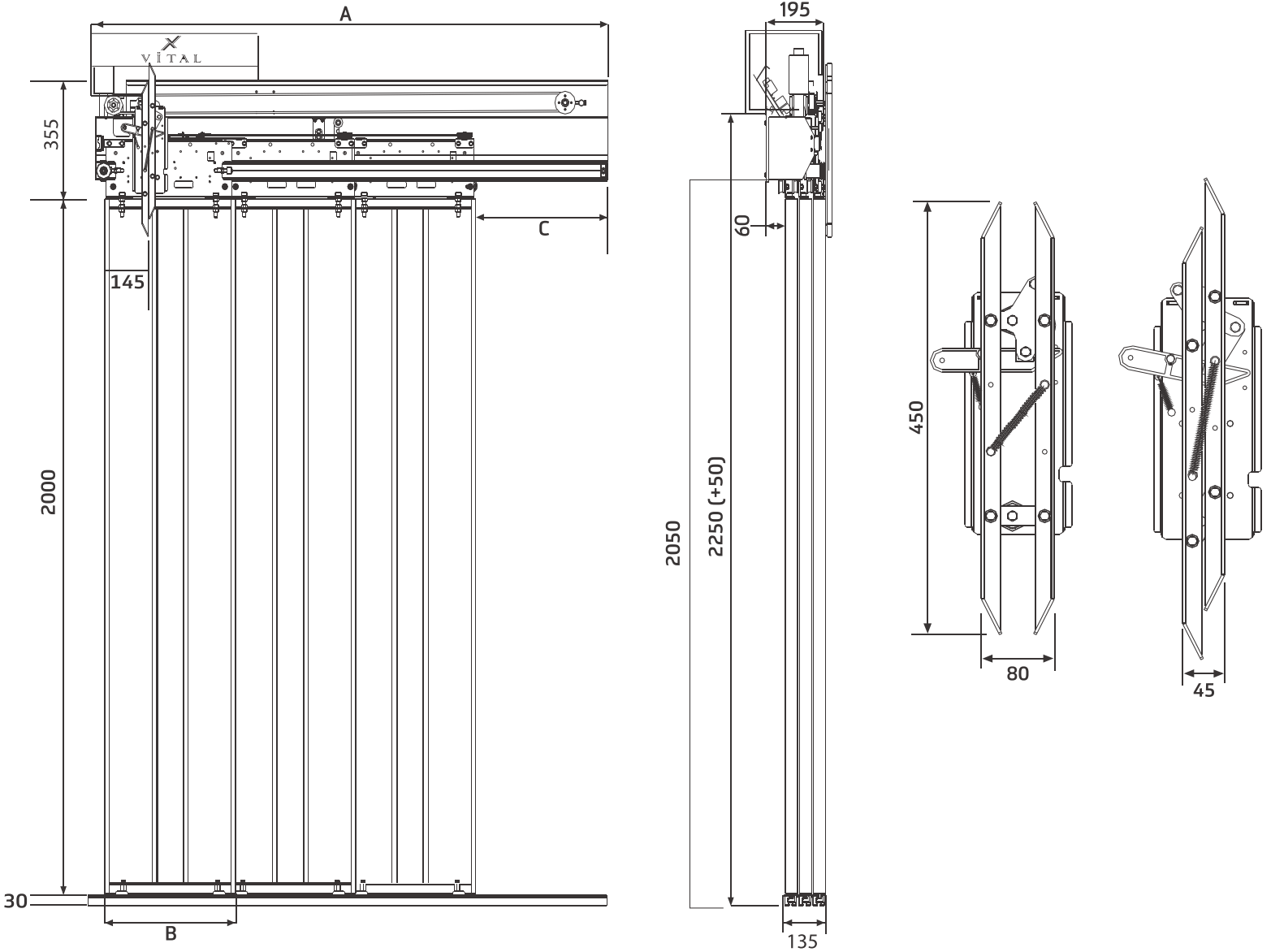

V i DOOR

Ölçüler / Dimensions

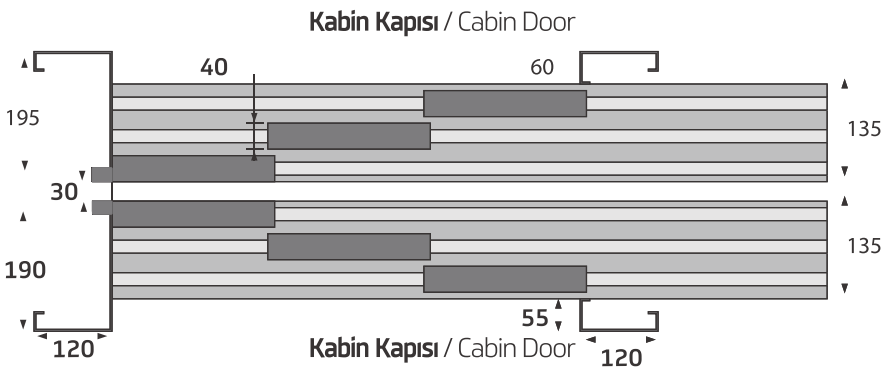

PL (mm)	A (mm)	B (mm)	C (mm)
800	1117	287	297
900	1250	320	330
1000	1383	353	363
1100	1517	387	397
1200	1650	420	430
1300	1783	453	463
1400	1917	487	497
1500	2050	521	531
1600	2183	554	564



2 PANEL

MERKEZİ KABİN KAPISI

Merkezi 2 Panel Kabin Kapısı
Central Opening 2 Panel Cabin Door

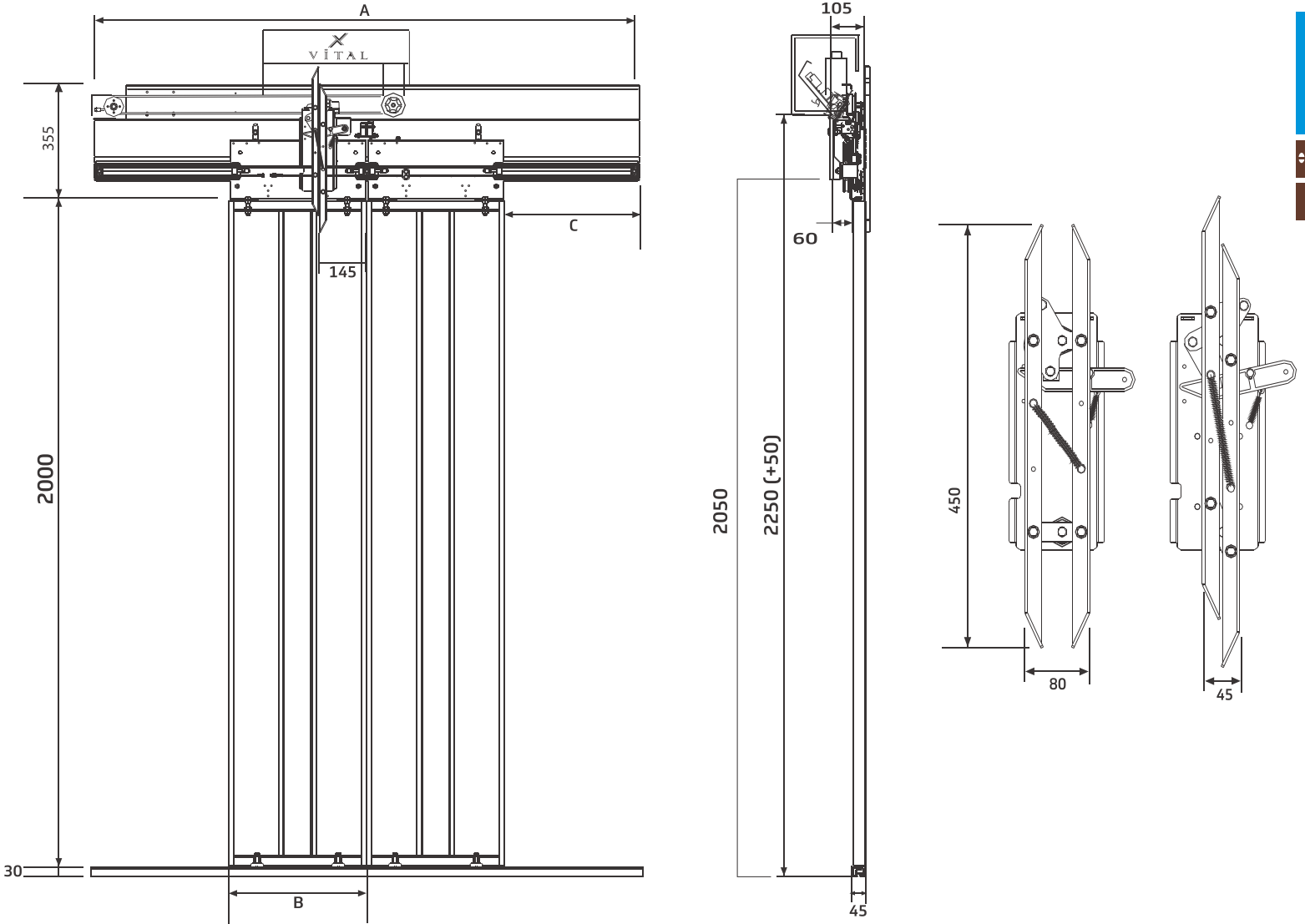

V i DOOR

Ölçüler / Dimensions

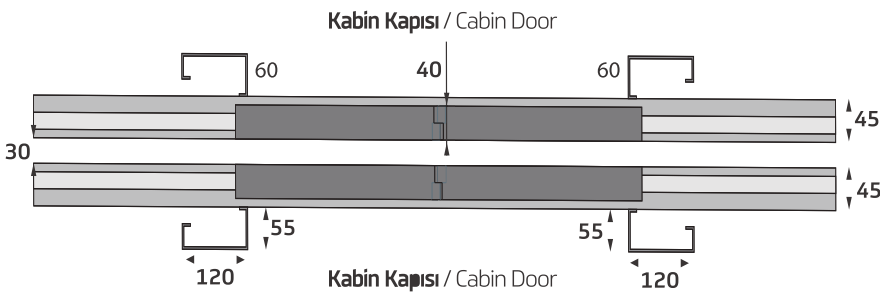

PL (mm)	A (mm)	B (mm)	C (mm)
700	1450	370	380
800	1650	420	430
900	1850	470	480
1000	2050	520	530
1100	2250	570	580
1200	2450	620	630
1300	2650	670	680
1400	2850	720	730
1500	3050	770	780
1600	3250	820	830



4 PANEL

MERKEZİ KABİN KAPISI

Merkezi 4 Panel Kabin Kapısı
Central Opening 4 Panel Cabin Door

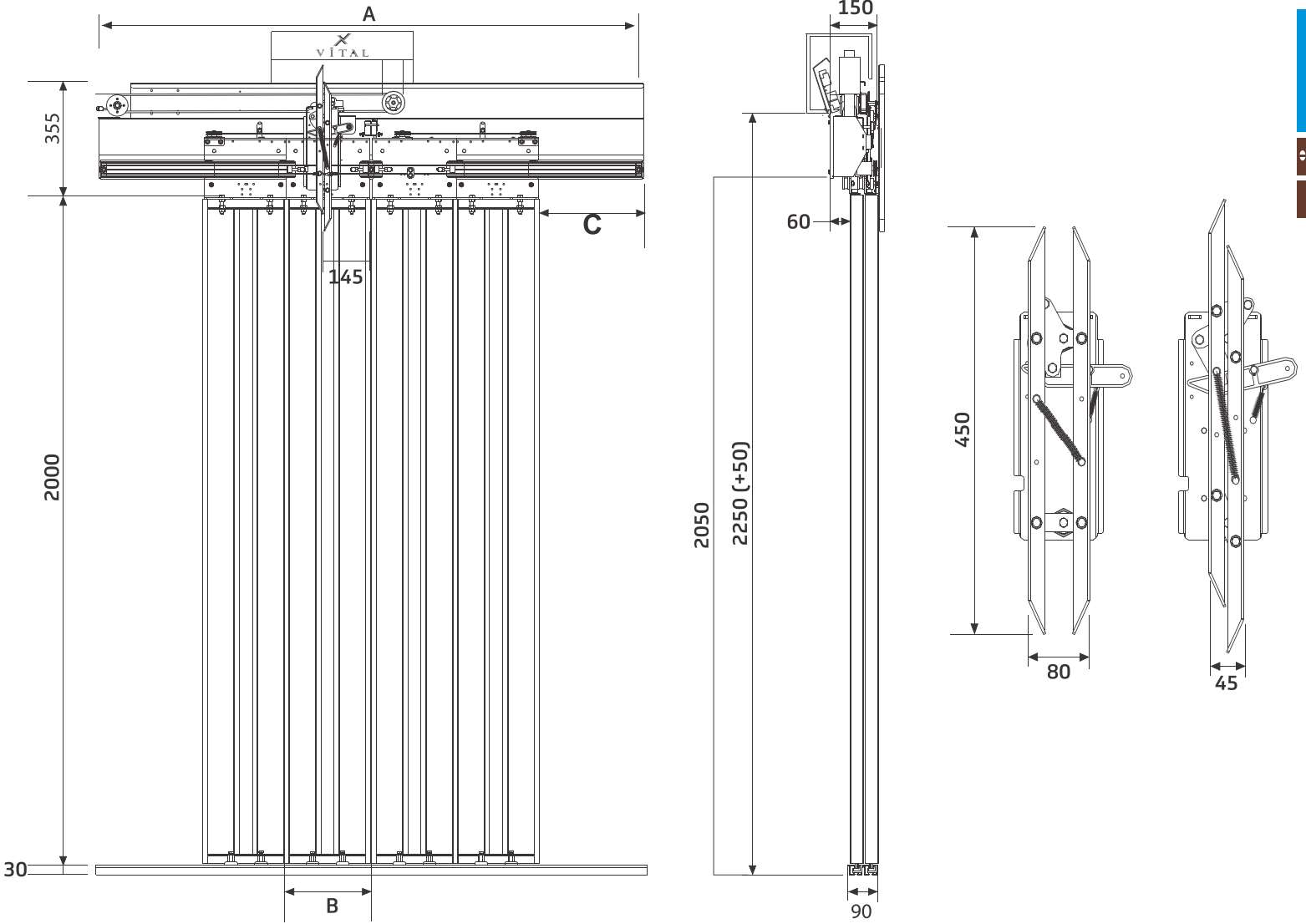

V i DOOR

Ölçüler / Dimensions

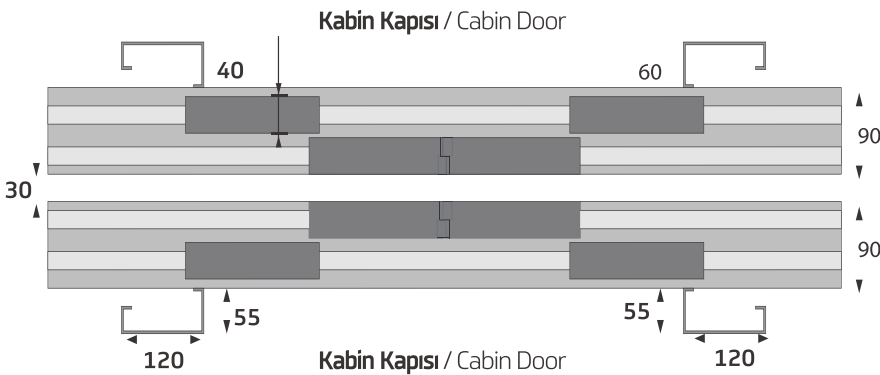

PL (mm)	A (mm)	B (mm)	C (mm)
1000	1550	270	280
1100	1700	295	305
1200	1850	320	330
1300	2000	345	355
1400	2150	370	380
1500	2300	395	405
1600	2450	420	430
1700	2600	445	455
1800	2750	470	480



2 PANEL

TELESKOPİK KAT KAPISI

Teleskopik 2 Panel Kat Kapısı
Teleskopik 2 Panel Landing Door

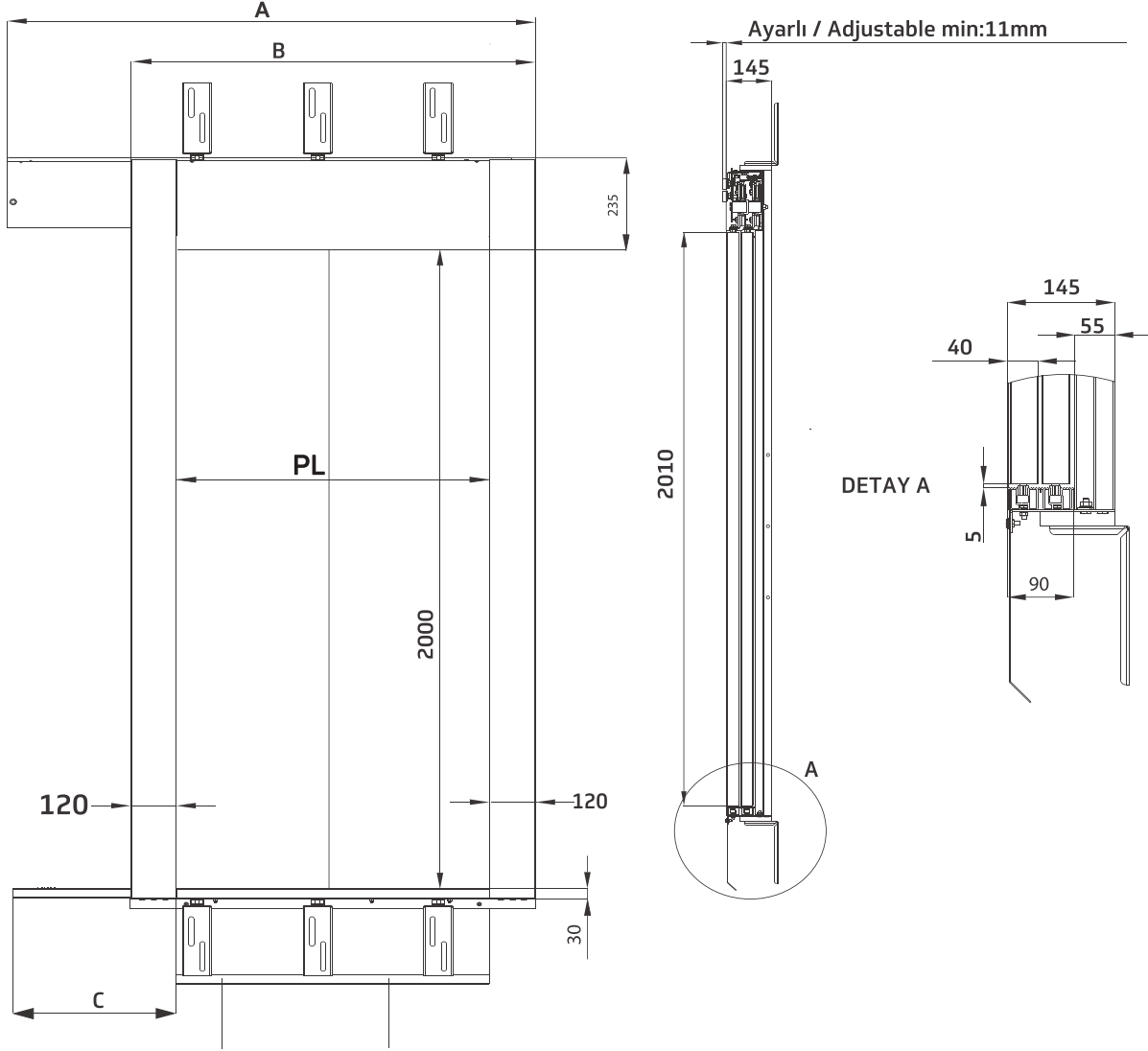

Ölçüler / Dimensions

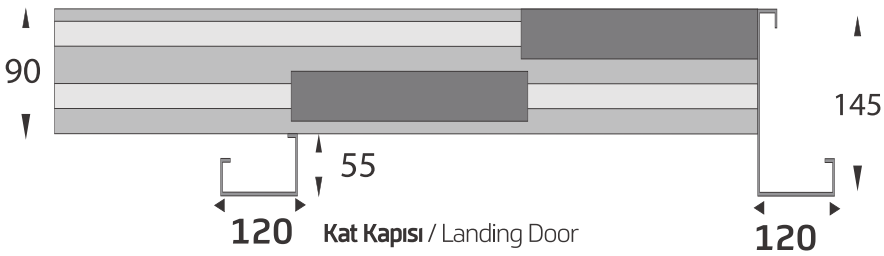

PL (mm)	A (mm)	B (mm)	C (mm)
700	1200	940	380
800	1350	1040	430
900	1500	1140	480
1000	1650	1240	530
1100	1800	1340	580
1200	1950	1440	630
1300	2100	1540	680
1400	2250	1640	730
1500	2400	1740	780
1600	2550	1840	830



3 PANEL

TELESKOPİK KAT KAPISI

Teleskopik 3 Panel Kat Kapısı
Telescopic 3 Panel Landing Door

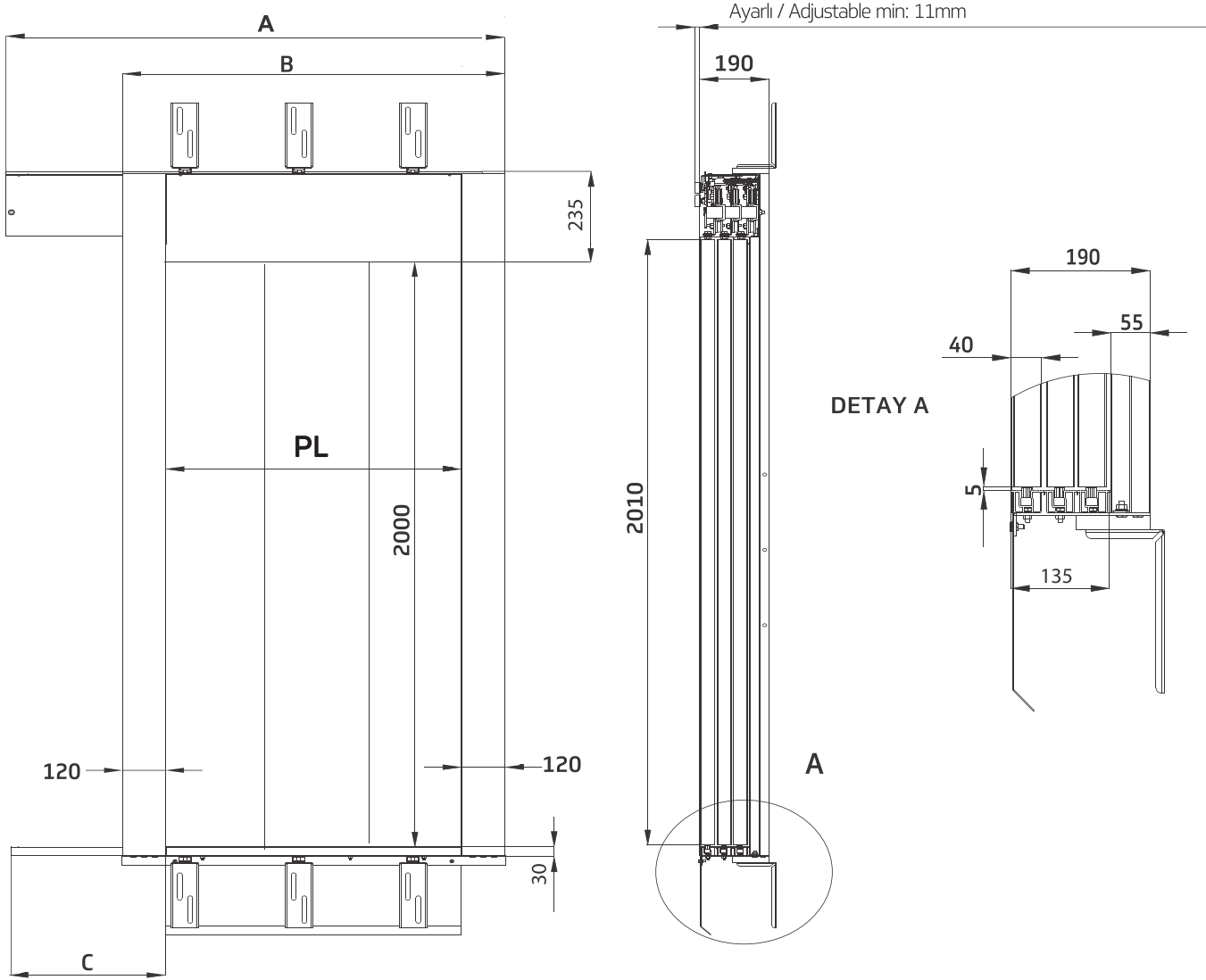

Ölçüler / Dimensions

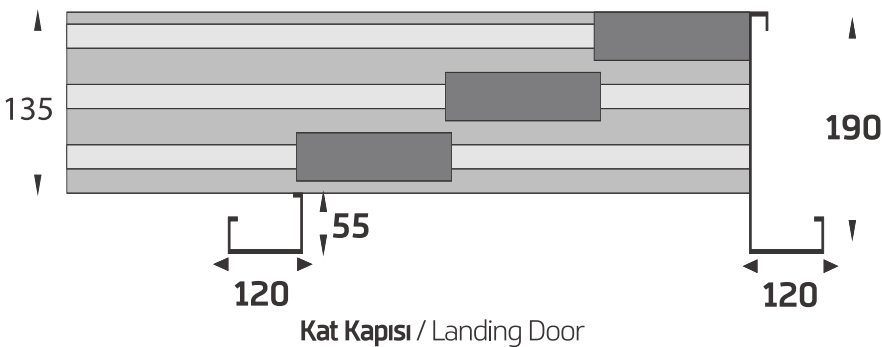

PL (mm)	A (mm)	B (mm)	C (mm)
800	1217	1040	297
900	1350	1140	330
1000	1483	1240	363
1100	1617	1340	397
1200	1750	1440	430
1300	1883	1540	463
1400	2017	1640	497
1500	2150	1740	530
1600	2283	1840	563



2 PANEL

MERKEZİ KAT KAPISI

Merkezi 2 Panel Kat Kapısı
Central Opening 2 Panel Landing Door

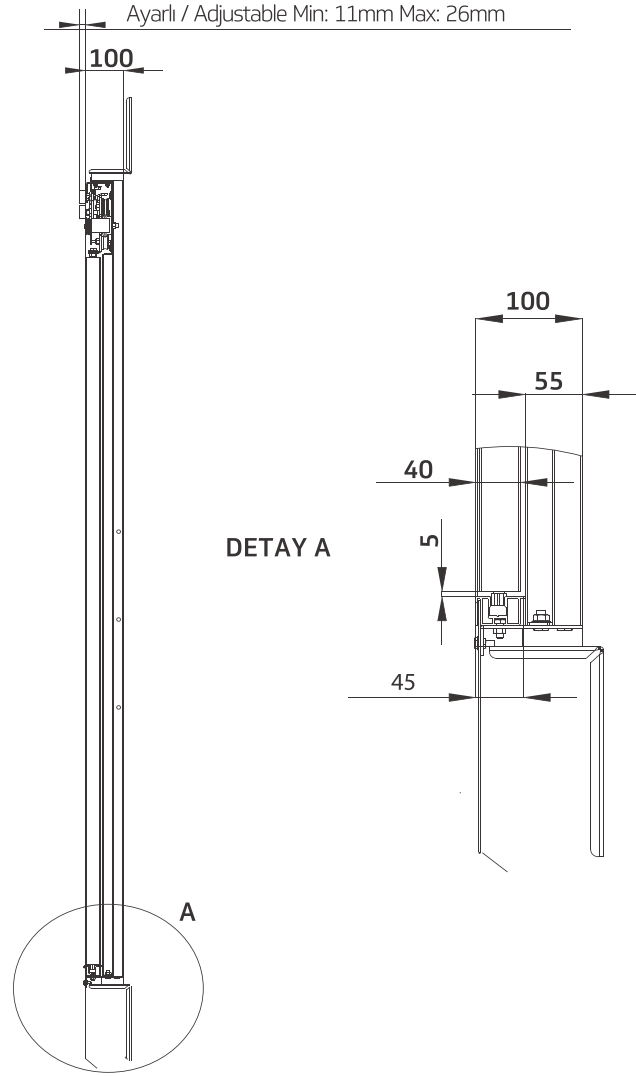
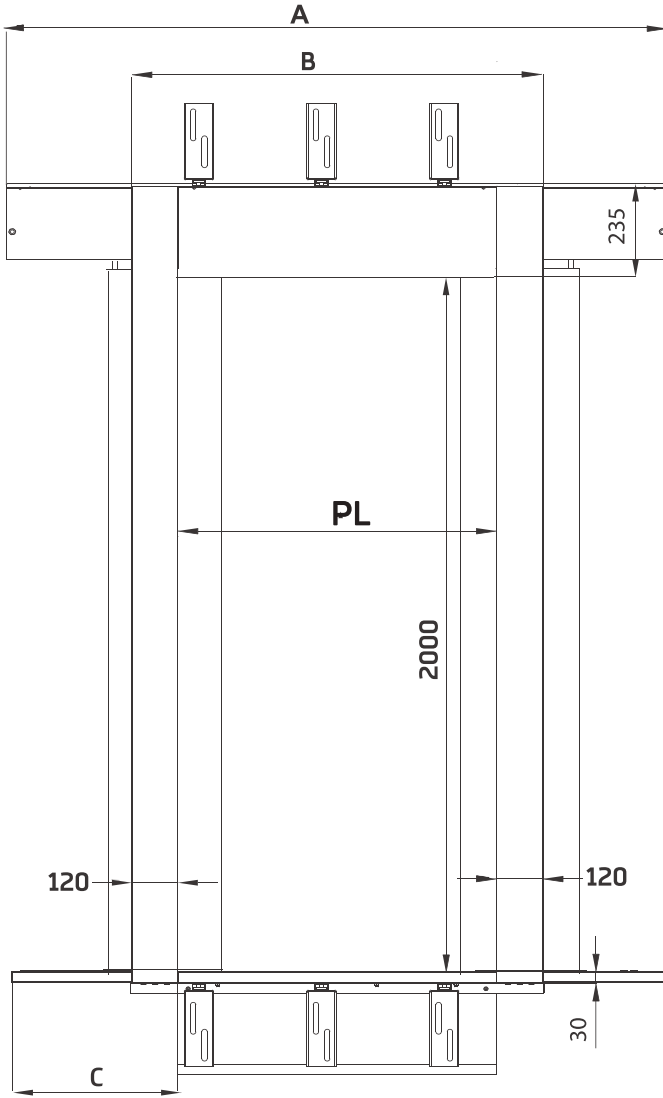

DETAY A

Ölçüler / Dimensions

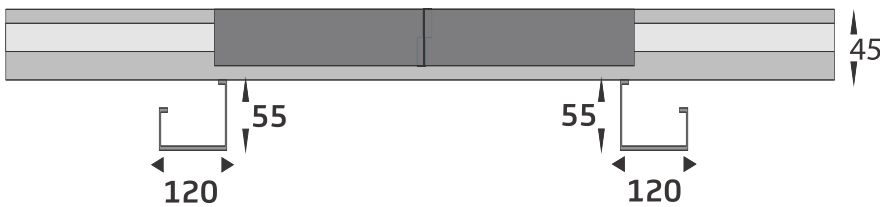

Kat Kapısı / Landing Door

PL (mm)	A (mm)	B (mm)	C (mm)
700	1450	940	380
800	1650	1040	430
900	1850	1140	480
1000	2050	1240	530
1100	2250	1340	580
1200	2450	1440	630
1300	2650	1540	680
1400	2850	1640	730
1500	3050	1740	780
1600	3250	1840	820

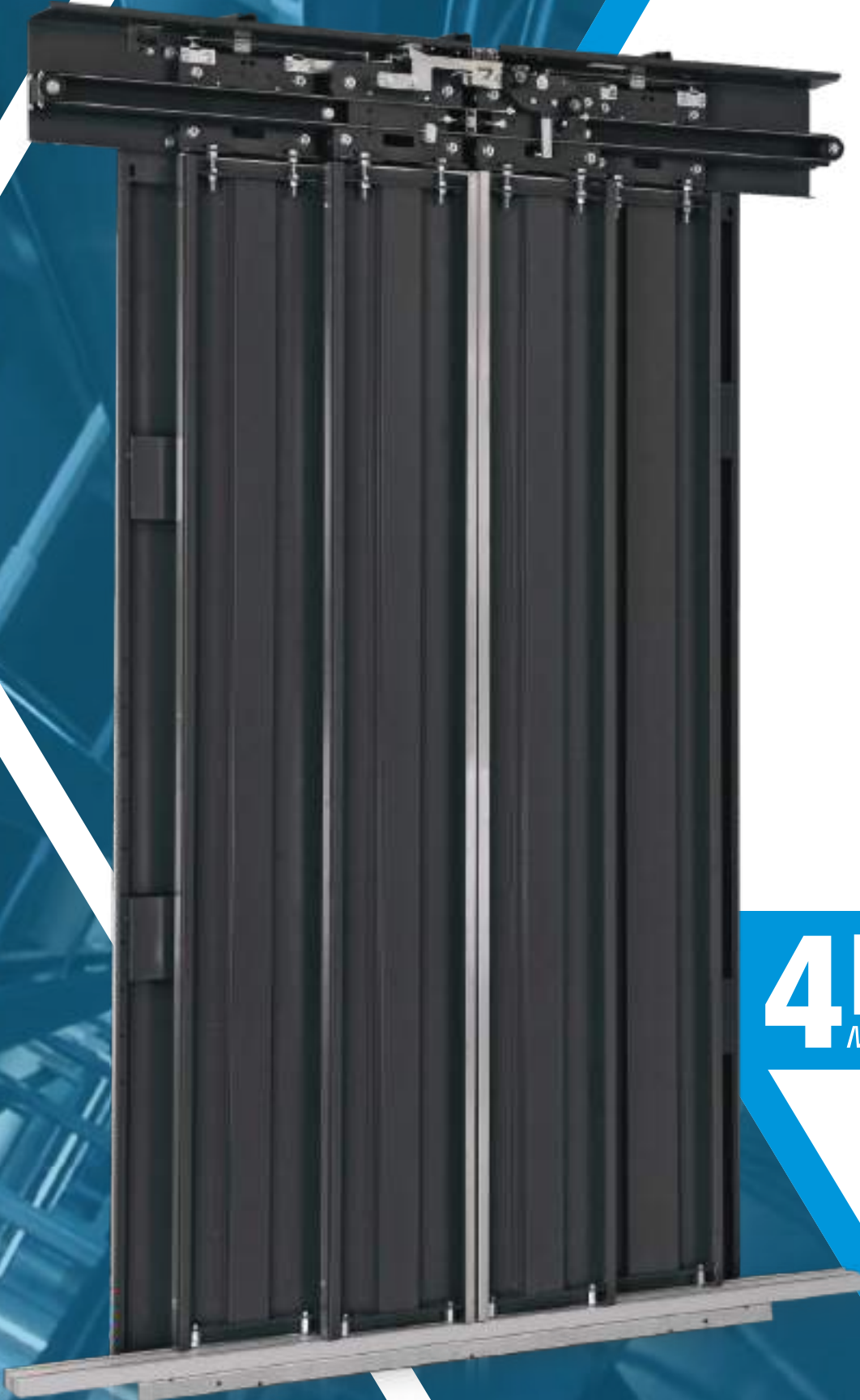

4 PANEL

MERKEZİ KAT KAPISI

Merkezi 4 Panel Kat Kapısı
Central Opening 4 Panel Landing Door

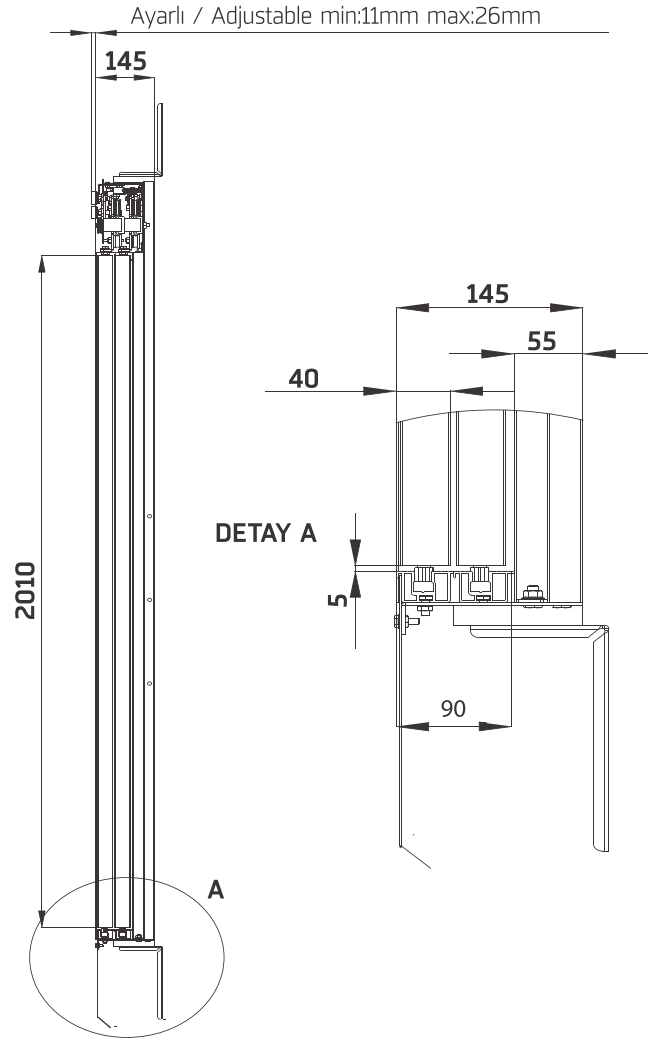
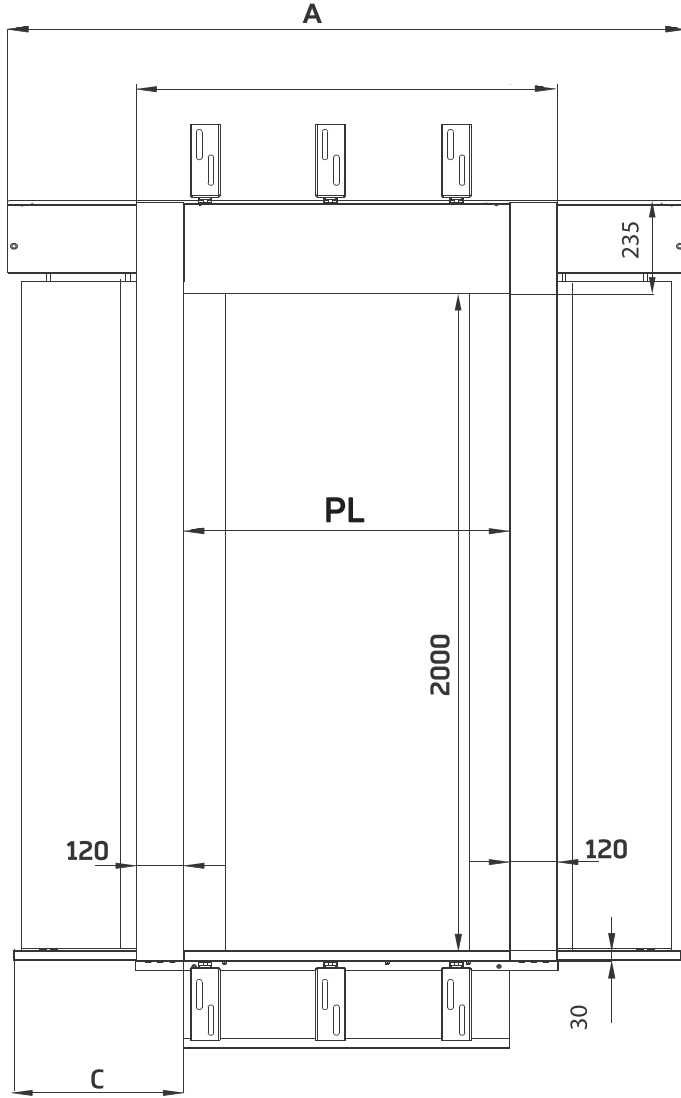

Ölçüler / Dimensions

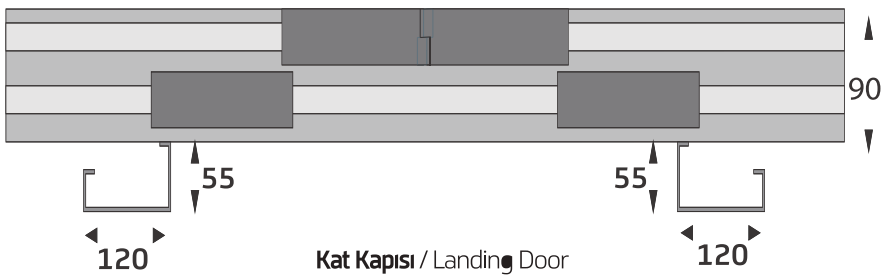

PL (mm)	A (mm)	B (mm)	C (mm)
1000	1550	1240	280
1100	1700	1340	305
1200	1850	1440	330
1300	2000	1540	355
1400	2150	1640	380
1500	2300	1740	405
1600	2450	1840	430
1700	2600	1940	455
1800	2750	2040	480



2 PANEL

YARI OTO. TELESKOPİK KABİN KAPISI

Yarı Otomatik Teleskopik 2 Panel Kabin Kapısı
Semi-Automatic Telescopic 2 Panel Cabin Door

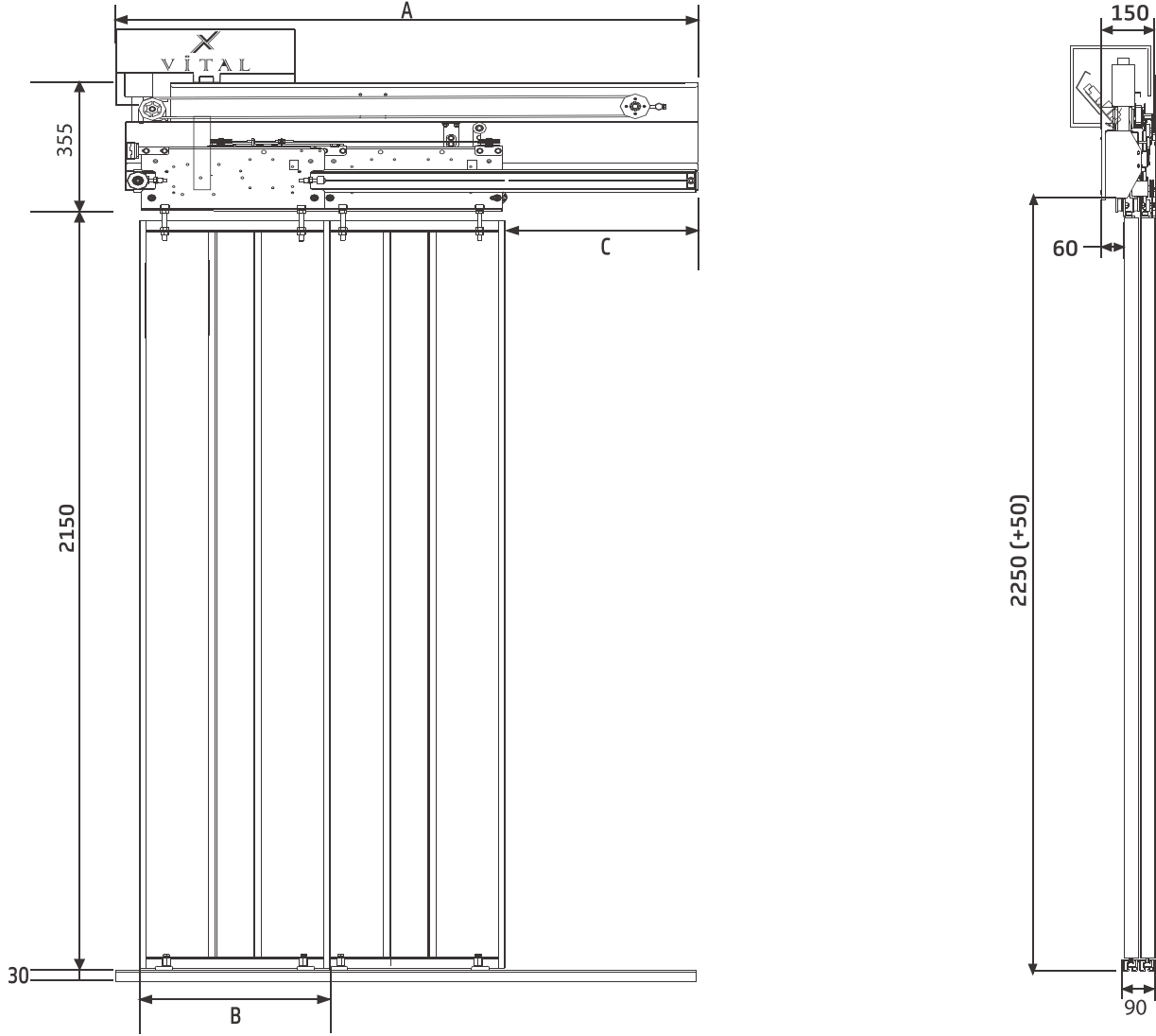

VİTAL DOOR

Ölçüler / Dimensions

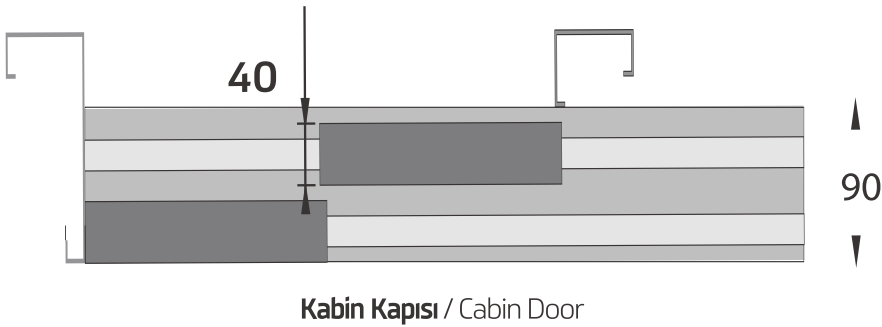

PL (mm)	A (mm)	B (mm)	C (mm)
700	1100	370	380
800	1250	420	430
900	1400	470	480
1000	1550	520	530
1100	1700	570	580
1200	1850	620	630
1300	2000	670	680
1400	2150	720	730
1500	2300	770	780
1600	2450	780	830



3 PANEL

YARI OTO. TELESKOPİK KABİN KAPISI

Yarı Otomatik Teleskopik 3 Panel Kabin Kapısı
Semi-Automatic Telescopic 3 Panel Cabin Door

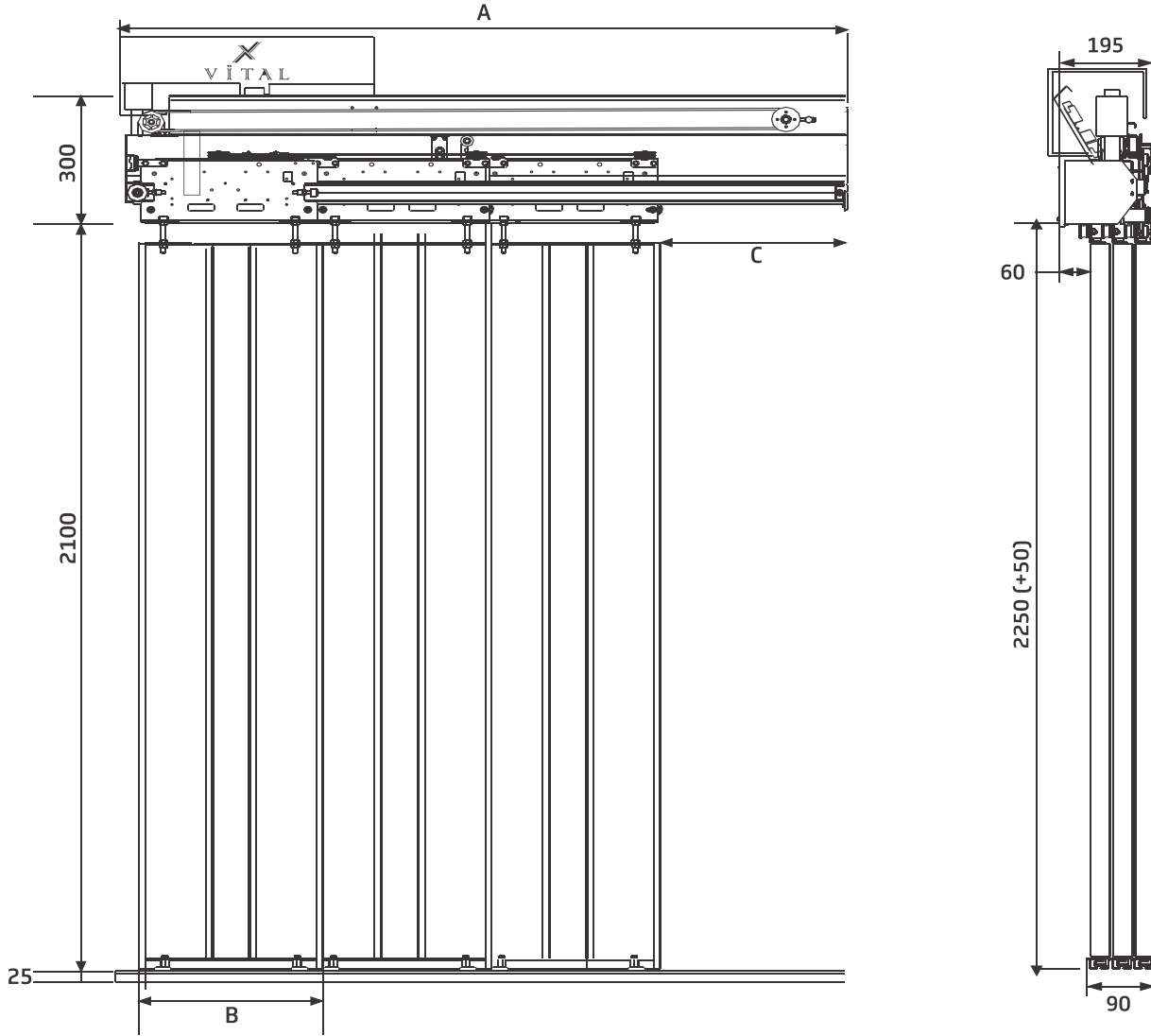

VİTAL DOOR

Ölçüler / Dimensions

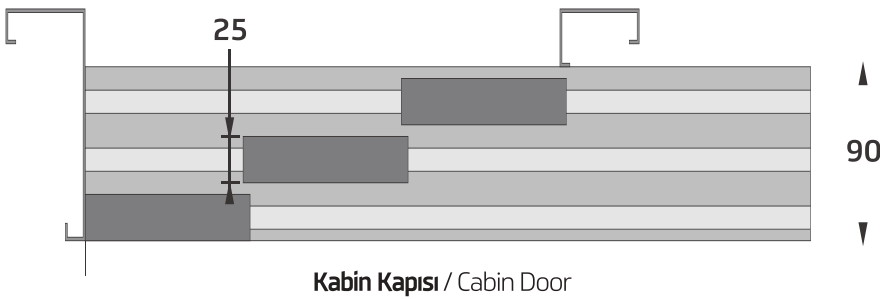

PL (mm)	A (mm)	B (mm)	C (mm)
700	963	246	256
800	1096	280	290
900	1230	313	323
1000	1363	346	356
1100	1496	380	390
1200	1630	413	423
1300	1763	446	456
1400	1896	480	490
1500	2030	514	524
1600	2163	547	558



2 PANEL

YARI OTO. MERKEZİ KABİN KAPISI

Yarı Otomatik Merkezi 2 Panel Kabin Kapısı
Semi-Automatic Central Opening 2 Panel Cabin Door

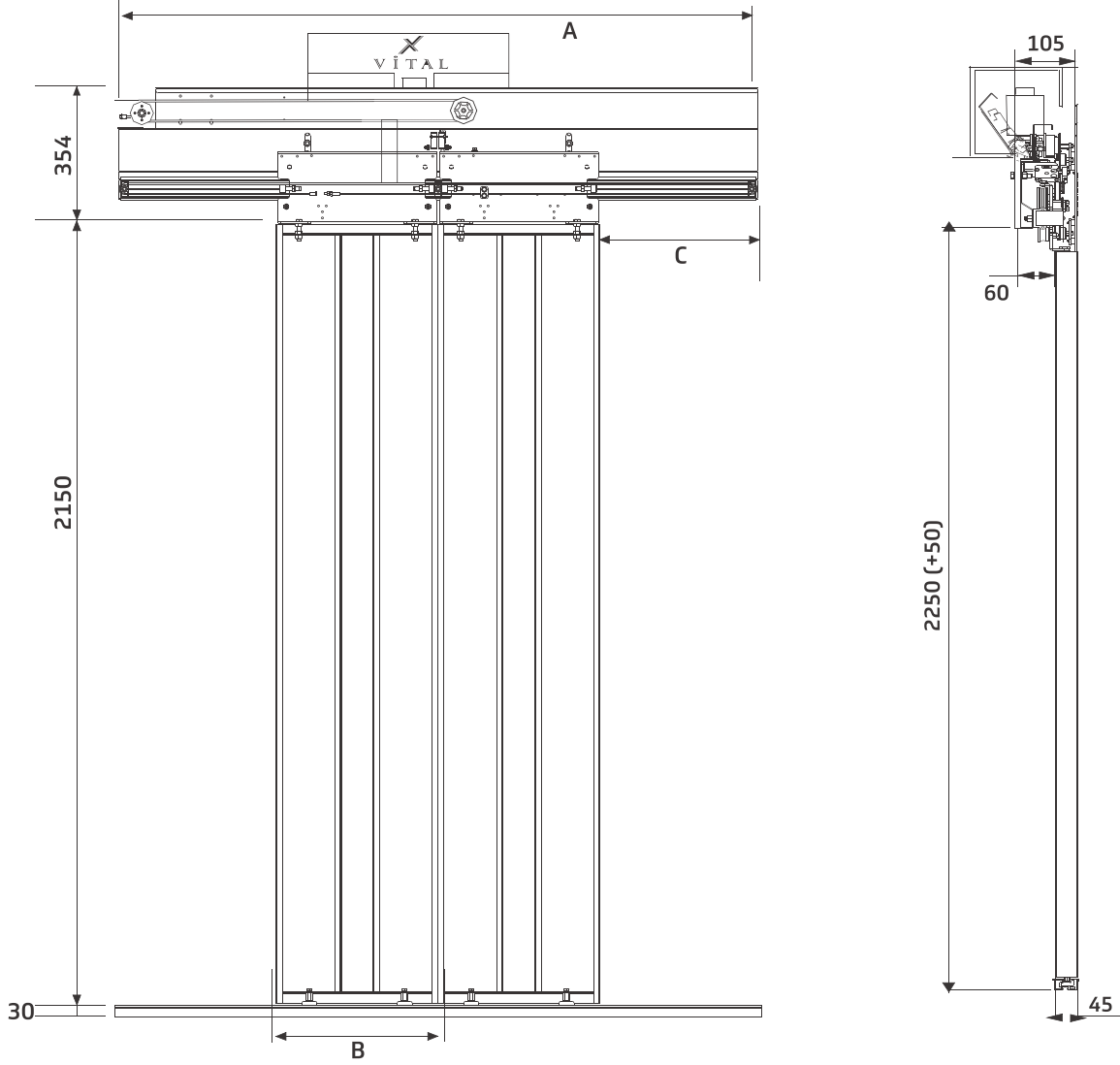

Ölçüler / Dimensions

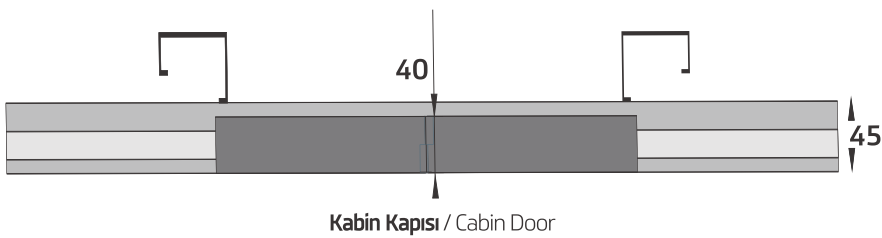

PL (mm)	A (mm)	B (mm)	C (mm)
700	1450	370	380
800	1650	420	430
900	1850	470	480
1000	2050	520	530
1100	2250	570	580
1200	2450	620	630
1300	2650	670	680
1400	2850	720	730
1500	3000	770	780
1600	3150	820	830

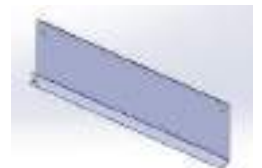
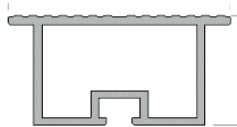

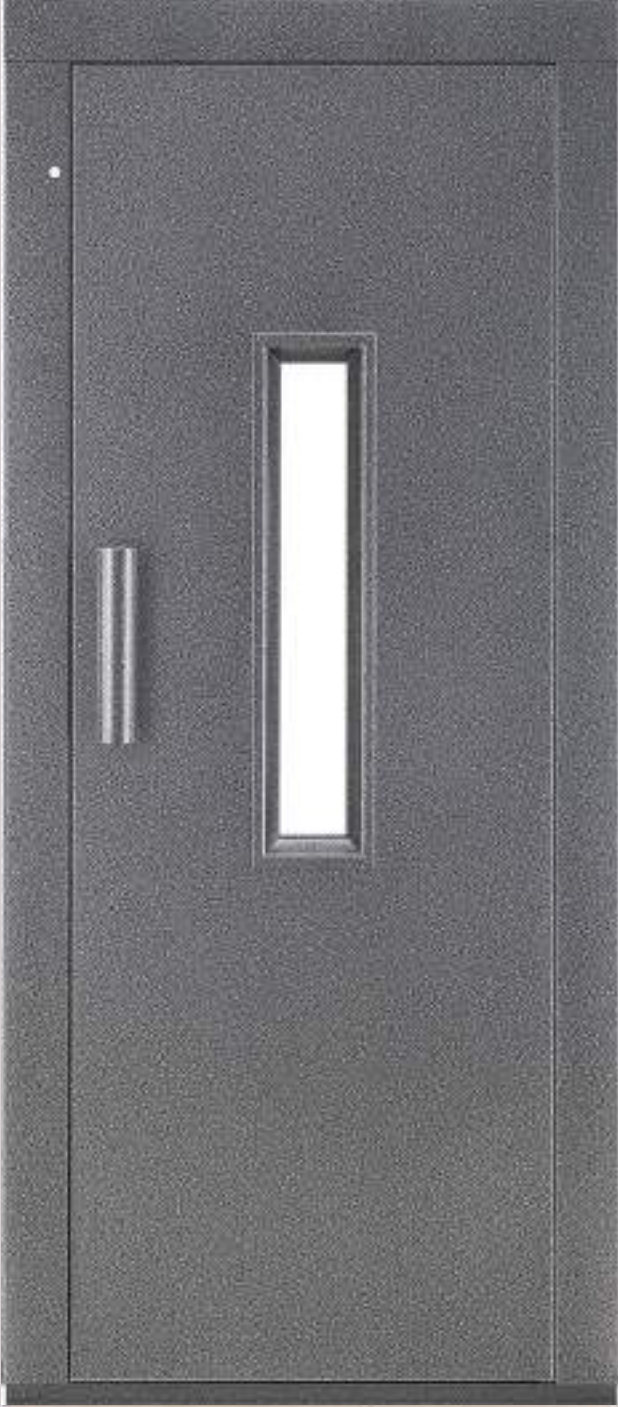

V i DOOR



ASANSÖR KONTROL SİSTEMLERİ LIFT CONTROL SYSTEMS

Vİ
PANO



Durak Sayısı / Number of floor	64
Elektrik Tesisatı / Electrical Cabling	Kabin ve kat butonyeri ile seri veya paralel bağlantı imkanı. / Serial or parallel connection options with LOPs and COPs ARCODE compatible serial communication units
Kabin pozisyon bilgisi / Cabin positioning	Manyetik şalter ya da motor enkoderi / Magnetic switches or motor encoder
Kapı Köprüleme / Door Brinding	Mevcut / Available
Modeller / Models	5.5 kW (14A) 7.5 kW (17A) 11 kW (26A) 15 kW (35A) 22 kW (50A) 37kW (75A)
Kumanda Tipi / Button Command Type	Tek Buton , Çift Buton , Basit Kumanda / One Button , Double Button , Non collective universal , Only on the direction of connected button.
Grup Tipi / Group Operation	8 Asansöre kadar / Up to 8 lifts
Asansör hızı / Lift Speed	Max : 4 m/s
Asansör Standardı / Lift Standards	En 81-1 / 2 +A3 , En81-20/50 , En81-28 , En81-72 , En81-73
Kalkış Tutma / Rollback Prevention	Ön-tork ve kalkış tutma fonksiyonları ile kalkışta geri kaymayı önleme / Rollback prevention at start through pre-torque and anti-rollback functions
Haberleşme Protokolü / Communication Protocol	CanBUS
Kurtarma Tipi / Rescue Type	60 VDC 5 Akü ile kata getirme / 60 VDC with 5 battery (we are using only this type)
Dil Seçeneği / Language Options	Türkçe , English , Russian , French , Spanish , Polish , German , Italian
Enkoder Opsiyonları / Encoder Options	5V TTL , 10-30V HTL , EnDat , SSI , SinCos , BISS

ARCODE

PANO



ADRIVE

VİTAL
PANO

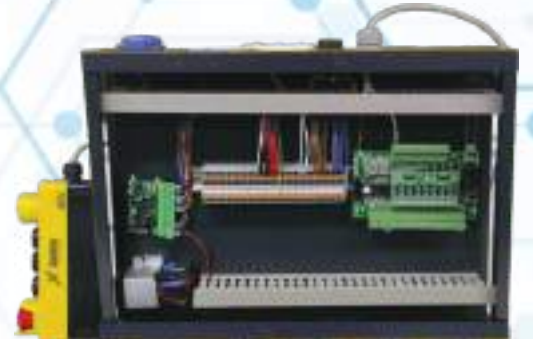

Durak Sayısı / Number of floor	24
Elektrik Tesisatı / Electrical Cabling	Kabin ve kat butonyeri ile paralel bağlantı. / Only parallel connections with COPs and LOPs
Kabin pozisyon bilgisi / Cabin positioning	Manyetik şalter ya da motor enkoderi / Magnetic switches or motor encoder
Kapı Köprüleme / Door Brindng	Mevcut / Available
Modeller / Models	5.5 kW (14A) 7.5 kW (17A) 11 kW (26A) 15 kW (35A) 22 kW (50A) 37kW (75A)
Kumanda Tipi / Button Command Type	Tek Buton , Çift Buton , Basit Kumanda / Single Button , Double Button , Non collective universal
Grup Tipi / Group Operation	4 Asansöre kadar / Up to 4 lifts
Asansör hızı / Lift Speed	Max : 1.6 m/s
Asansör Standardı / Lift Standards	En 81-1 / 2 +A3
Kurtarma Tipi / Rescue Type	60 VDC 5 Akü ile kata getirme / 60 VDC with 5 battery (we are using only this type)
Kalkış Tutma / Rollback Prevention	Ön-tork ve kalkış tutma fonksiyonları ile kalkışta geri kaymayı önleme / Rollback prevention at start through pre-torque and anti-rollback functions
Dil Seçeneği / Language Options	Türkçe , English , French , Spanish , Russian
Enkoder Opsiyonları / Encoder Options	5V TTL , 10-30V HTL , EnDat , SSI , SinCos , BISS

ARCUBE

Durak Sayısı / Number of floor	16
Elektrik Tesisatı / Electrical Cabling	Kabin ve kat butonyeri ile seri veya paralel bağlantı imkanı. / Serial or parallel connection options with LOPs and COPs ARCODE compatible serial communication units
Kabin pozisyon bilgisi / Cabin positioning	Manyetik şalter ya da motor enkoderi / Magnetic switches or motor encoder
Kapı Köprüleme / Door Brinding	Mevcut / Available
Modeller / Models	5.5 kW (14A) 7.5 kW (17A) 11 kW (26A)
Kumanda Tipi / Button Command Type	Tek Buton , Çift Buton , Basit Kumanda / Single Button , Double Button , Non collective universal
Grup Tipi / Group Operation	4 Asansöre kadar / Up to 4 lifts
Asansör hızı / Lift Speed	Max : 1.75 m/s
Asansör Standardı / Lift Standards	En 81-1 / 2 +A3 , En81-20/50 , En81-28
Kurtarma Tipi / Rescue Type	60 VDC 5 Akü ile kata getirme / 60 VDC with 5 battery (we are using only this type)
Kalkış Tutma / Rollback Prevention	Ön-tork ve kalkış tutma fonksiyonları ile kalkışta geri kaymayı önleme / Rollback prevention at start through pre-torque and anti-rollback functions
Dil Seçeneği / Language Options	Türkçe , English , Russian , French , Spanish , Polish , German , Italian
Enkoder Opsiyonları / Encoder Options	5V TTL , 10-30V HTL , EnDat , SSI , SinCos , BISS

VİTAL GRUP
PANO



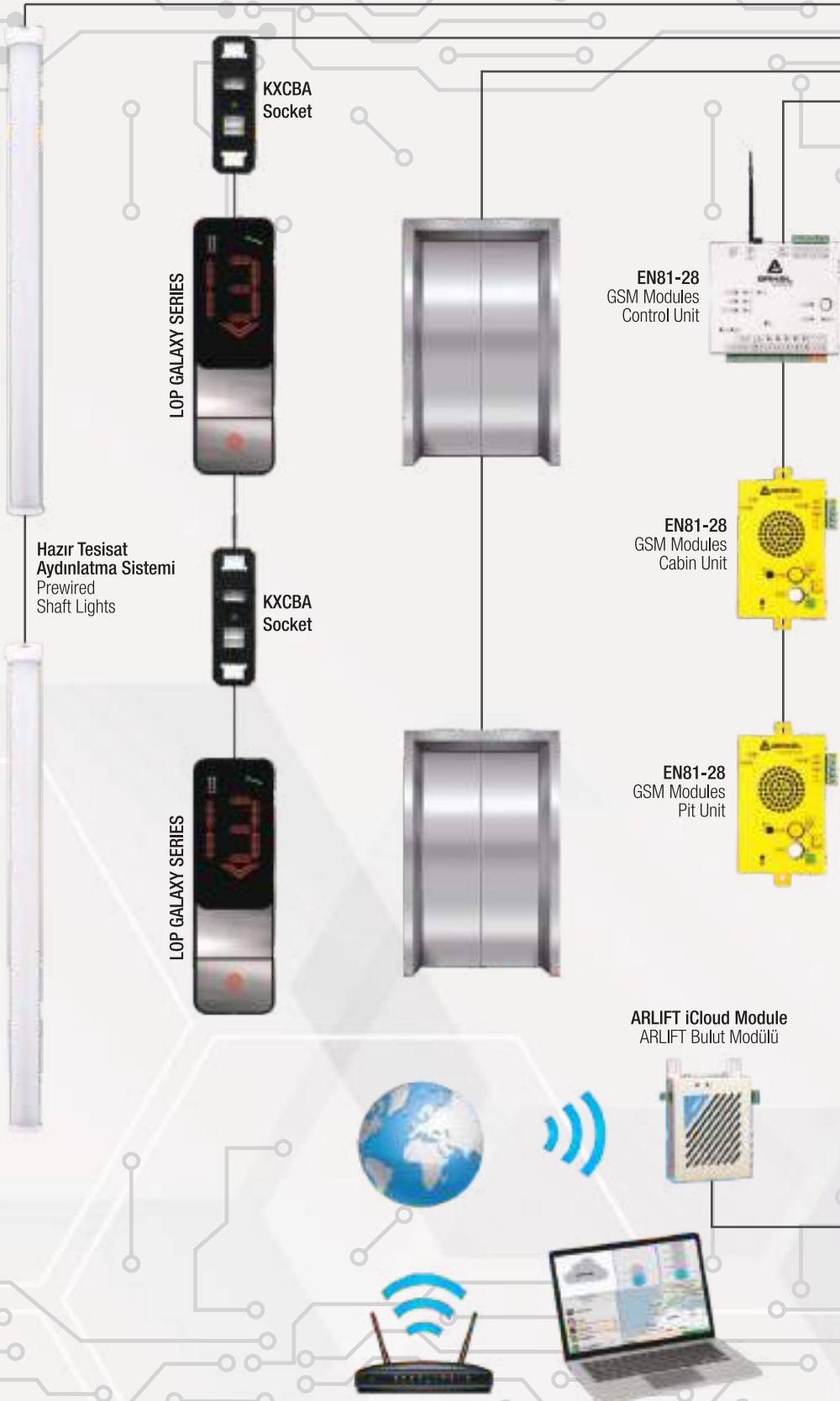

! Reduce the time and effort up to %60 by using our innovative plug & play solution.



Fast



Quality



Protected



Certificated



Easy



Prorammmable



Safe

Akü Grubu
Batteries For Emergency



EN 81-20/50



EN 81-1/-2+A3



EN 81-70



EN 81-72



EN 81-73



Motor Acil Stop
Emergency Stop



Dişlisiz Makine
Gearless Machine



Regülâtör
Overspeed Governor

Fotosel
Photocell



Liftsense

3. Floor

2. Floor

1. Floor

Makaralı Şalter
Limit Switches

Makaralı Şalter
Limit Switches



GALAXY SERIES

PANO



AREM



G&Z Plus
Music Module

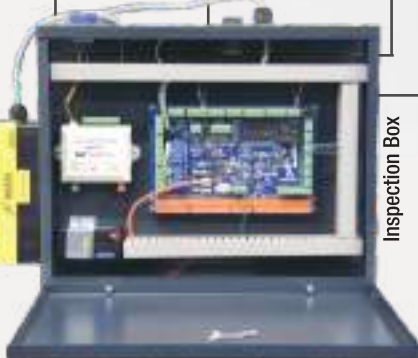

Inspection Box

Overload Control Ünite
Aşırı Yük Kontrol Ünitesi



Intercom

Flexible
Takoðu

Flexible
Attachment

Flexible
Takoðu

Emergency
Light

Under Cabin
Buzzer

Pitbox
Kuyu Dibi Kutusu

Pit Ligthing
Control

Emergency
Stop

9x0,75 mm + 11x0,50 mm NYAF CABLE

Vİ
İ
PANO



U31TM0001



U21TM0015



U20KU0002



U20KU0004



U20KU0003



U21YR0005



U21YR0028



U20SM0033



U20SM0018



U28SM0001



U20SM0001



U20SM0014

OPSIYONLAR | OPTIONS



GSM Communication



Flush Mounted



Surface Mounted



Touch Button



Access Control



Voice Communication



Panel Surfaces



Administration Equipment



Glass Desing



L.RM.4050



L.AVAC.4210



FUSION
9316.M7VD.QD



HERA
7215.DS2X



AVOX
7315.M7VD



L.RC.1011



L.RTAC.1012.WB



L.AVPW.1072



SGI800



SGI300



PGI280



LGNP2000FBSM

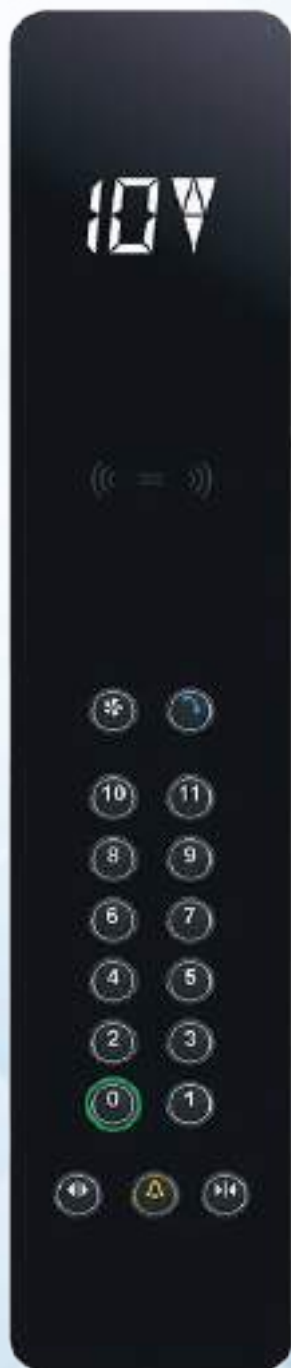

SGPN1000SM



DGPN1000



PGT281



SGST301



LGT281

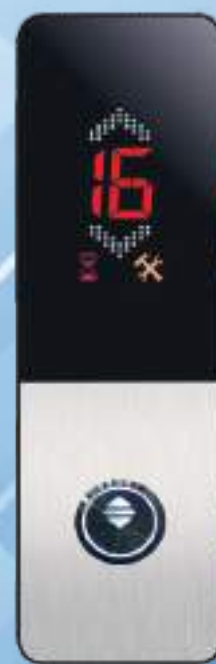

SGT301

Vital PANO

GEAR/DİŞLİLİ



EKER SMART



EKER STRONG LITE



EKER STRONG PLUS



EKER STRONG



MONTANARI MR



AKIŞ MUGEN



ALBERTO SASSI



SICOR MR



AKIŞ ZF



EKER FORCE



AKIŞ VOLPİ

GEARLESS/DİŞLİSİZ



AKIŞ AK



AKIŞ VOLPİ



AKIŞ S



EKER QUITE



MONTANARI MGv



ZIEHL ABEGG ZATOP



ALBERTO SASSI G



SICOR SG



WITTUR WSG



EMF SQML



SICOR SGS



Vİ
MAK



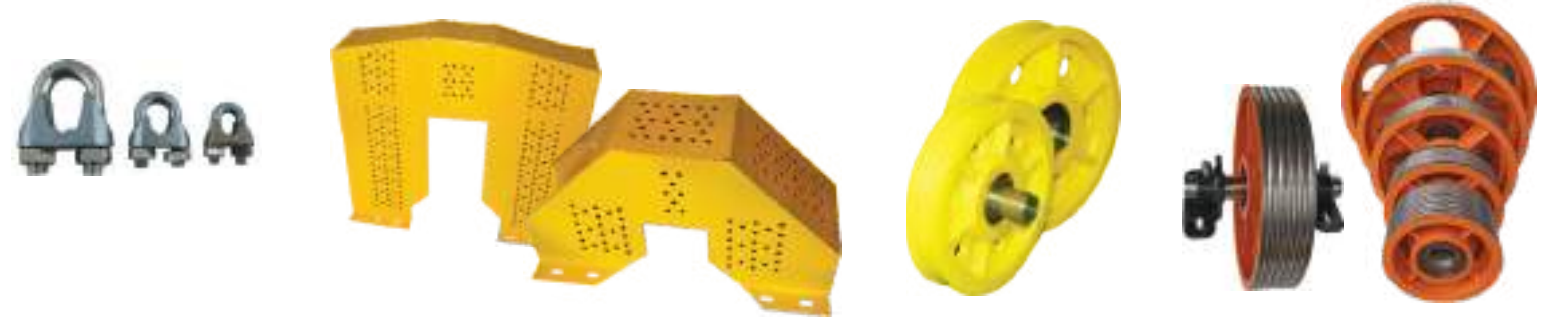







VITAL LIFT



Hasta Asansörleri (sınıf I-II) Fonksiyonel Boyutlar / Patient Lifts (class I-II) Functional Dimensions

TAŞIMA KAPASİTESİ / Capacity			(Kg)	1600	2000	2500
KABİN ALANI / Cabin space			(min)	3,245	3,82	4,625
			(max)	3,56	4,2	5
KABİN EBATLARI Cabinet Dimensions	Genişlik / Width	b1	(mm)	1400	1500	1800
	Derinlik / Depth	d1	(mm)	2400	2700	2700
	Yükseklik / Height		(mm)	2300	2300	2300
DURAK KAPILARI Stall Doors	Genişlik / Width	b2	(mm)	1300	1300	1300
	Yükseklik / Height	h3	(mm)	2100	2100	2100
KUYU EBATLARI Pit dimensions	Genişlik / Width	b3	(mm)	2400	2400	2700
	Derinlik / Depth	d2	(mm)	3000	3200	3300
KUYU DİBİ DERİNLİĞİ Elevator Pit Bottom	Vn=0,63m/sn	d3	(mm)	1600	1600	1800
	Vn=1,00m/sn	d3	(mm)	1700	1700	1900
	Vn=1,60m/sn	d3	(mm)	1900	1900	2100
	Vn=2,50m/sn	d3	(mm)	2500	2500	2500
EN ÜST DURAK SEVİYESİ ÜSTÜNDEKİ YÜKSEKLİK Height Above the Highest Stall Level	Vn=0,63m/sn	h1	(mm)	4400	4400	4400
	Vn=1,00m/sn	h1	(mm)	4400	4400	4600
	Vn=1,60m/sn	h1	(mm)	4400	4400	4600
	Vn=2,50m/sn	h1	(mm)	5400	5400	5600
MAKİNA DAİRESİ Engine Room	ALAN / Space	A	(m2)	25	27	29
	GENİŞLİK / Width	b4	(mm)	3200	3200	3500
	DERİNLİK / Depth	d4	(mm)	5500	5800	5800
	YÜKSEKLİK / Height	h2	(mm)	2800	2800	2800

Yük Asansörleri (sınıf IV) Fonksiyonel Boyutlar / Load Elevators (Class IV) Functional Dimensions

TAŞIMA KAPASİTESİ / Carriage Quality			(Kg)	630	1000	1600	2000
KABİN EBATLARI Cabinet Dimensions	Genişlik / Width	b1	(mm)	1100	1300	1500	1500
	Derinlik / Depth	d1	(mm)	1400	1750	2250	2700
	Yükseklik / Height		(mm)	2200	2300	2200	2200
DURAK KAPILARI Stall Doors	Derinlik / Depth	b2	(mm)	1100	1300	1500	1500
	Yükseklik / Height	h3	(mm)	2100	2100	2100	2100
KUYU EBATLARI Pit Dimensions	Genişlik / Width	b3	(mm)	2100	2400	2700	2700
	Derinlik / Depth	d2	(mm)	1900	2300	2800	3200
KUYU DİBİ DERİNLİĞİ Elevator Pit Bottom	V<1,00m/sn	d3	(mm)	1500	1500	1700	1700
EN ÜST DURAK SEVİYESİ ÜSTÜNDEKİ YÜKSEKLİK Height Above the Highest Stall Level	V<1,00m/sn	h1	(mm)	4100	4100	4300	4300
MAKİNA DAİRESİ Engine Room	ALAN / Space	A	(mm)	12	14	18	20
	GENİŞLİK / Width	b4	(mm)	2800	3100	3400	3400
	DERİNLİK / Depth	d4	(mm)	3500	3800	4500	4900
	YÜKSEKLİK / Height	h2	(mm)	2200	2200	2400	2400

Servis Asansörleri (sınıf V) Fonksiyonel Boyutlar / Service Elevators (Class V) Functional Dimensions

TAŞIMA KAPASİTESİ / Carriage Quality			(Kg)	40	100	250
KABİN EBATLARI Cabinet Dimensions	Genişlik / Width	b1	(mm)	600	800	1000
	Derinlik / Depth	d1	(mm)	600	850	1000
	Yükseklik / Height		(mm)	800	800	1200
KUYU EBATLARI Pit Dimensions	Genişlik / Width	b3	(mm)	900	1100	1500
	Derinlik / Depth	d2	(mm)	800	1000	1200

İnsan Asansörleri (Sınıf I-II) Fonksiyonel Boyutlar / Passenger Elevators (Class I-II) Functional Dimensions

				KONUTLAR / HOUSES				İŞYERLERİ / OFFICES					
TAŞIMA KAPASİTESİ			(Kg)	320	400	630	1000	630	800	1000	1250	1600	
ANMA YÜKÜ / NOMINAL LOAD			(Kişi)	4	5	8	13	8	10	13	16	21	
KABİN ALANI / CABIN SPACE			(min)	0,79	0,98	1,45	2,15	1,45	1,73	2,15	2,57	3,245	
			(max)	0,95	1,17	1,66	2,40	1,66	2,00	2,40	2,90	3,56	
KABİN EBATLARI CABIN DIMENSIONS	Genişlik / Width	b1	(mm)	900	1100	1100	1100	1100	1350	1600	1950	1950	
	Derinlik / Depth	d1	(mm)	1000	1000	1400	2100	1400	1400	1400	1400	1750	
	Yükseklik / Height	h4	(mm)	2200	2200	2200	2200	2200	2200	2300	2300	2300	
DURAK KAPILARI LANDING DOORS	Genişlik	b2	(mm)	700	800	800	800	800	800	1100	1100	1100	
	Yükseklik	h3	(mm)	2000	2000	2000	2000	2000	2000	2100	2100	2100	
KUYU EBATLARI SHAFT DIMENSIONS	Genişlik 1*	b3	(mm)	1400	1600	1600	1600						
	Genişlik 2**	b3	(mm)		1800	1800	1800	1800	1900	2400	2600	2600	
	Derinlik	d2	(mm)	1600	1600	1900	2600	2100	2300	2300	2300	2600	
KUYU DİBİ DERİNLİĞİ PIT	0,63m/sn	d3	(mm)	1400	1400	1400	1400	1400	1400	1400	1600	1600	
	1,00m/sn	d3	(mm)	1400	1400	1400	1400	1400	1400	1400	1600	1600	
	1,60m/sn	d3	(mm)		1600	1600	1600	1600	1600	1600	1600	1600	
	2,50m/sn	d3	(mm)			2200	2200		2200	2200	2200	2200	
EN ÜST DURAK SEVİYESİ ÜSTÜNDEKİ YÜKSEKLİK OVERHEAD	0,63m/sn	h1	(mm)	3600	3600	3600	3600	3800	3800	4200	4400	4400	
	1,00m/sn	h1	(mm)	3700	3700	3700	3700	3800	3800	4200	4400	4400	
	1,60m/sn	h1	(mm)	3800	3800	3800	3800	4000	4000	4200	4400	4400	
	2,50m/sn	h1	(mm)			5000	5000		5000	5200	5400	5400	
M A K i M A N C H A I N E A R O R E M S i	ALAN SPACE	0,63m/sn	A	(m2)	6	7,5	10	12	15	15	20	22	25
		1,00m/sn	A	(m2)	6	7,5	10	12	15	15	20	22	25
		1,60m/sn	A	(m2)		10	12	14	15	15	20	22	25
		2,50m/sn	A	(m2)			14	16		18	20	22	25
	GENİŞLİK WIDTH	0,63m/sn	h1	(mm)	1600	2200	2200	2400	2500	2500	3200	3200	3200
		1,00m/sn	h1	(mm)	1600	2200	2200	2400	2500	2500	3200	3200	3200
		1,60m/sn	h1	(mm)		2200	2200	2400	2500	2500	3200	3200	3200
		2,50m/sn	h1	(mm)			2800	2800		2800	3200	3200	3200
	DERİNLİK DEPTH	0,63m/sn	d4	(mm)	3000	3200	3700	4200	3700	3700	4900	4900	5500
		1,00m/sn	d4	(mm)	3000	3200	3700	4200	3700	3700	4900	4900	5500
		1,60m/sn	d4	(mm)		3200	3700	4200	3700	3700	4900	4900	5500
		2,50m/sn	d4	(mm)			3700	4200		3700	4900	4900	5500
	YÜKSEKLİK HEIGHT	0,63m/sn	h2	(mm)	2000	2000	2000	2000	2200	2200	2400	2400	2800
		1,00m/sn	h2	(mm)	2000	2000	2000	2000	2200	2200	2400	2400	2800
		1,60m/sn	h2	(mm)		2200	2200	2200	2200	2200	2400	2400	2800
		2,50m/sn	h2	(mm)			2600	2600		2800	2800	2800	2800

*Sağa veya sola toplanan teleskopik kapılı asansörler için / For telescopic elevators with doors opening to the right and left

**Merkezden açılan kapılı asansörler için / For elevators with central opening

320 ve 400 Kg. taşıma kapasiteli asansörler engelli kişilerin tekerlekli sandalyede asansörü kullanmaları için uygun değildir
Elevators with a load capacity of 320 and 420 kg are not suitable for use by people with disabilities in a wheelchair



KALİTEYİ VE GÜVENİ TAŞIYORUZ...

Quality and Trust We carry

VİTAL GRUP

COMPLETE ELEVATOR SYSTEMS

3. Organize Sanayi Bölgesi Büyükkaysık Mh. 9. Sk. No:31 Selçuklu/Konya
T: +90 332 345 13 85 F: +90 332 345 13 88

[bilgi@vitalasensor.com](mailto: bilgi@vitalasensor.com) | [export@vitalasensor.com](mailto: export@vitalasensor.com) | [satis@vitalasensor.com](mailto: satis@vitalasensor.com)
www.vitalasensor.com



VİPAR **VİDOOR** **VİPANO** **VİMAK** **VİLİFT** SlimLIFT NormLIFT